

Bob

design **Noctis**
Modello registrato/
Registered design



↳ Disponibile in tutti i tessuti del nostro campionario
↳ Nelle Larghezze King, 180, 160, Queen, 150, 140, 120, Twin, 90

↳ Available in all the fabrics of our catalogue
↳ Bed sizes available: King, 180, 160, Queen, 150, 140, 120, Twin, 90

Varianti/ Version

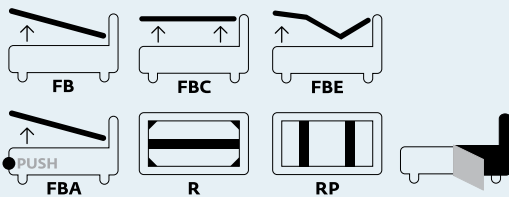

I disegni tecnici fanno riferimento al letto fornito con piedi standard. Al variare dei piedi variano anche l'altezza complessiva del letto e il piano d'appoggio del materasso. The production drawings are referred to the bed with standard feet. Any foot change will also imply a change of the height and of the mattress base.

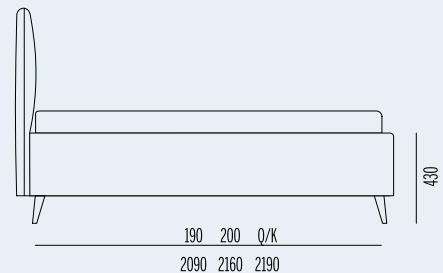
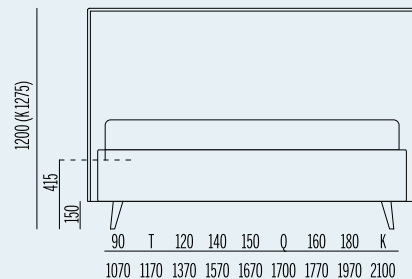

Folding box®

↳ Include rete ortopedica a doghe con doppio palo di sostegno centrale con 14 doghe in betulla da 65mm ▶ Sistema fondo brevettato Folding box® ▶ Altezza fascia contenitore h 27 cm ▶ Sistema di apertura tradizionale con molle a gas ▶ Including an orthopedic staves bed frame with double central support and fourteen 65 mm birchen staves ▶ Patented Folding box® bottom system for an easy cleaning of the storage area ▶ External height of the storage area: 27 cm ▶ Traditional opening system



Folding box® comfort

↳ Include rete ortopedica a doghe con doppio palo di sostegno centrale con 14 doghe in betulla da 65mm ▶ Sistema fondo brevettato Folding box® ▶ Altezza fascia contenitore h 27 cm ▶ Sistema di apertura comfort a rete parallela ▶ Including an orthopedic staves bed frame with double central support and fourteen 65 mm birchen staves ▶ Patented Folding box® bottom system for an easy cleaning of the storage area ▶ External height of the storage area: 27 cm ▶ Comfort parallel frame opening system



Folding box® automatic

↳ Include rete ortopedica a doghe con doppio palo di sostegno centrale con 14 doghe da 65 mm in betulla ▶ Sistema fondo brevettato Folding box® ▶ Altezza fascia contenitore h 27 cm ▶ Sistema di apertura automatico a pulsante elettrico con alimentazione 24 v ▶ Fornito con trasformatore e sistemi di sicurezza ▶ Including an orthopedic staves bed frame with double central support and fourteen 65 mm birchen staves ▶ Patented Folding box® bottom system for an easy cleaning of the storage area ▶ External height of the storage area: 27 cm ▶ Automatic electromechanical opening system - 24V power ▶ Provided with transformer and safety equipment



Folding box® ergonomics

↳ Include rete ortopedica a doghe con movimentazione elettrica e ergonomica ▶ Sistema fondo brevettato Folding box® ▶ Altezza fascia contenitore h 27 cm con vano interno ridotto a causa dell'ingombro rete ▶ Sistema di apertura tradizionale con molle a gas ▶ Including an ergonomic staves bed frame ▶ Patented Folding box® bottom system for an easy cleaning of the storage area ▶ External height of the storage area: 27 cm ▶ traditional opening system ▶ The storage area is reduced due to the different bed frame transformer and safety equipment



Ring

↳ Non include la rete ▶ Predisposizione per rete in appoggio su angolari e palo centrale longitudinale ▶ Piano di appoggio reteregolabile su 2 livelli incassati di h 1 - 60 mm h 2 - 125 mm rispetto al bordo del giroletto ▶ The bed frame is not included ▶ Angles and central bars are preset for a bed frame ▶ The bearing surface is adjustable at 2 heights h 1 - 60 mm h 2 - 125 mm referring to the bed frame



Ring pfi

↳ Non include la rete ▶ Predisposizione per rete in appoggio su barre trasversali (nr.2) ▶ Piano di appoggio rete regolabile su 4 livelli incassati di h 1 - 95 mm, h 2 - 120 mm h 3 - 145 mm, h 4 - 170 mm rispetto al bordo del giroletto ▶ The bed frame is not included ▶ The lateral bars are preset for a bed frame (nr.2) ▶ The bearing surface is adjustable at 4 heights h 1 - 95 mm, h 2 - 120 mm h 3 - 145 mm, h 4 - 170 mm Referring to the bed frame



Sfoderabilità Removable cover

↳ Quasi tutti i letti della nostra collezione prevedono il rivestimento tessile completamente sfoderabile ▶ Puoi facilmente riconoscerli nelle pagine del catalogo quando vedi questo simbolo nella relativa scheda tecnica ▶ Nearly all the beds of our collection have a completely removable cover ▶ You can recognize them in this catalogue by this symbol near the technical features

Bob h 17

h 17



⇨ Sfoderabile
⇨ Disponibile in tutti i tessuti del nostro campionario
⇨ Nelle Larghezze: King, 180, 160, Queen, 150, 140, 120, Twin, 90

⇨ Removable cover
⇨ Available in all the fabrics of our catalogue
⇨ Bed sizes available: King, 180, 160, Queen, 150, 140, 120, Twin, 90

Varianti/ Version

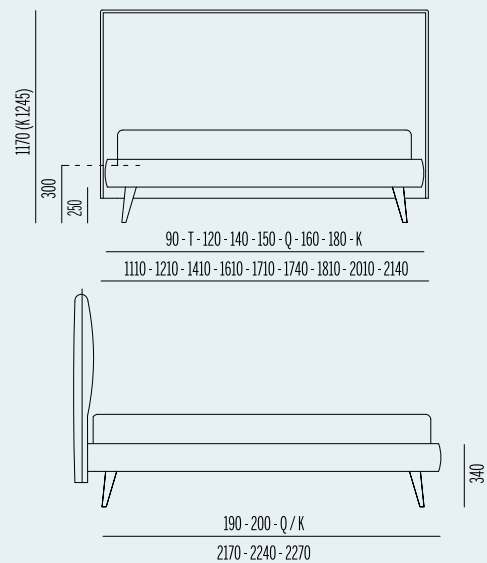
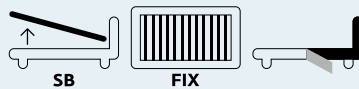

Fix
▷ Include rete ortopedica a doghe con palo di sostegno centrale con 14 doghe da 65mm in betulla ▷ La rete costituisce il telaio portante del letto
▶ Including an orthopedic staves bed frame with double central support and fourteen 65 mm birchen staves
▷ The bed frame is also the main frame of the bed



Secret Box®
▷ Include rete ortopedica a doghe con doppio palo di sostegno centrale con doghe 14mm in betulla
▷ Sistema brevettato Secret Box® con cassetto scorrevole
▷ Altezza interna contenitore cm 15
▷ Sistema di apertura tradizionale con molle a gas
▶ Includes orthopedic slatted bedstead with double central support pole with 14mm birch slats.
▷ Secret Box® patented system with sliding drawer.
▷ Internal container height 15 cm.
▷ Traditional opening system with gas springs.



Sfoderabilità Removable cover
▷ Quasi tutti i letti della nostra collezione prevedono il rivestimento tessile completamente sfoderabile
▷ Puoi facilmente riconoscerli nelle pagine del catalogo quando vedi questo simbolo nella relativa scheda tecnica
▶ Nearly all the beds of our collection have a completely removable cover
▷ You can recognize them in this catalogue by this symbol near the technical features

Bob Stripes

design **Noctis**

Modello registrato/
Registered design



↳ Disponibile in tutti i tessuti del nostro campionario tranne in pelle e ecopelle
↳ Nelle Larghezze King, 180, 160, Queen, 150, 140, 120, Twin, 90

↳ Available in all the fabrics of our catalogue except for leather and e-leather
↳ Bed sizes available: King, 180, 160, Queen, 150, 140, 120, Twin, 90

Varianti/ Version

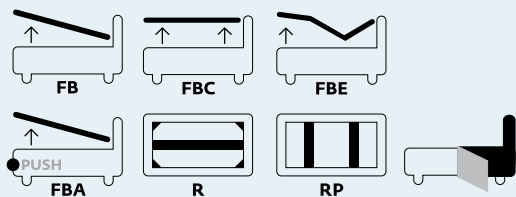

I disegni tecnici fanno riferimento al letto fornito con piedi standard. Al variare dei piedi variano anche l'altezza complessiva del letto e il piano d'appoggio del materasso. The production drawings are referred to the bed with standard feet. Any foot change will also imply a change of the height and of the mattress base.

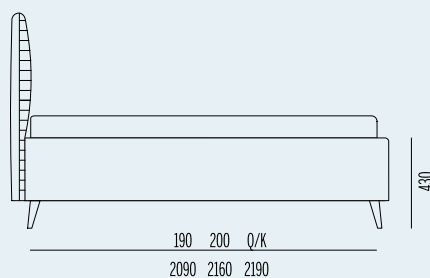
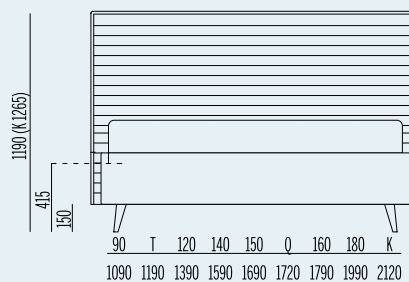

Folding box®

↳ Include rete ortopedica a doghe con doppio palo di sostegno centrale con 14 doghe in betulla da 65mm ▶ Sistema fondo brevettato Folding box® ▶ Altezza fascia contenitore h 27 cm ▶ Sistema di apertura tradizionale con molle a gas ▶ Including an orthopedic staves bed frame with double central support and fourteen 65 mm birchen staves ▶ Patented Folding box® bottom system for an easy cleaning of the storage area ▶ External height of the storage area: 27 cm ▶ Traditional opening system



Folding box® comfort

↳ Include rete ortopedica a doghe con doppio palo di sostegno centrale con 14 doghe in betulla da 65mm ▶ Sistema fondo brevettato Folding box® ▶ Altezza fascia contenitore h 27 cm ▶ Sistema di apertura comfort a rete parallela ▶ Including an orthopedic staves bed frame with double central support and fourteen 65 mm birchen staves ▶ Patented Folding box® bottom system for an easy cleaning of the storage area ▶ External height of the storage area: 27 cm ▶ Comfort parallel frame opening system



Folding box® automatic

↳ Include rete ortopedica a doghe con doppio palo di sostegno centrale con 14 doghe da 65 mm in betulla ▶ Sistema fondo brevettato Folding box® ▶ Altezza fascia contenitore h 27 cm ▶ Sistema di apertura automatico a pulsante elettrico con alimentazione 24 v ▶ Fornito con trasformatore e sistemi di sicurezza ▶ Including an orthopedic staves bed frame with double central support and fourteen 65 mm birchen staves ▶ Patented Folding box® bottom system for an easy cleaning of the storage area ▶ External height of the storage area: 27 cm ▶ Automatic electromechanical opening system - 24V power ▶ Provided with transformer and safety equipment



Folding box® ergonomics

↳ Include rete ortopedica a doghe con movimentazione elettrica e ergonomica ▶ Sistema fondo brevettato Folding box® ▶ Altezza fascia contenitore h 27 cm con vano interno ridotto a causa dell'ingombro rete ▶ Sistema di apertura tradizionale con molle a gas ▶ Including an ergonomic staves bed frame ▶ Patented Folding box® bottom system for an easy cleaning of the storage area ▶ External height of the storage area: 27 cm ▶ traditional opening system ▶ The storage area is reduced due to the different bed frame transformer and safety equipment



Ring

↳ Non include la rete ▶ Predisposizione per rete in appoggio su angolari e palo centrale longitudinale ▶ Piano di appoggio reteregolabile su 2 livelli incassati di h 1 - 60 mm h 2 - 125 mm rispetto al bordo del giroletto ▶ The bed frame is not included ▶ Angles and central bars are preset for a bed frame ▶ The bearing surface is adjustable at 2 heights h 1 - 60 mm h 2 - 125 mm referring to the bed frame



Ring pfi

↳ Non include la rete ▶ Predisposizione per rete in appoggio su barre trasversali (nr.2) ▶ Piano di appoggio rete regolabile su 4 livelli incassati di h 1 - 95 mm, h 2 - 120 mm h 3 - 145 mm, h 4 - 170 mm rispetto al bordo del giroletto ▶ The bed frame is not included ▶ The lateral bars are preset for a bed frame (nr.2) ▶ The bearing surface is adjustable at 4 heights h 1 - 95 mm, h 2 - 120 mm h 3 - 145 mm, h 4 - 170 mm Referring to the bed frame



Sfoderabilità Removable cover

↳ Quasi tutti i letti della nostra collezione prevedono il rivestimento tessile completamente sfoderabile ▶ Puoi facilmente riconoscerli nelle pagine del catalogo quando vedi questo simbolo nella relativa scheda tecnica ▶ Nearly all the beds of our collection have a completely removable cover ▶ You can recognize them in this catalogue by this symbol near the technical features

Bob Stripes h 17

h
I 7



↗ Sfoderabile
↗ Disponibile in tutti i tessuti del nostro campionario tranne in pelle ed ecopelle
↗ Nelle Larghezze: King, 180, 160, Queen, 150, 140, 120, Twin, 90

↗ Removable cover
↗ Available in all the fabrics of our catalogue except for leather and e-leather
↗ Bed sizes available: King, 180, 160, Queen, 150, 140, 120, Twin, 90

Varianti/ Version

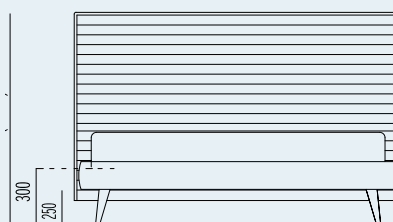
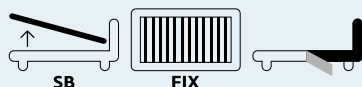

90 - T - 120 - 140 - 150 - Q - 160 - 180 - K
1110 - 1210 - 1410 - 1610 - 1710 - 1740 - 1810 - 2010 - 2140

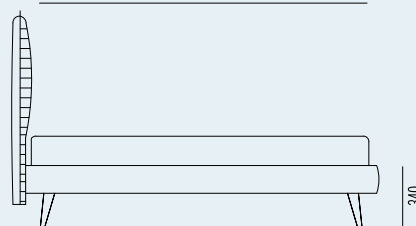

190 - 200 - Q / K
2170 - 2240 - 2270



Fix
▷ Include rete ortopedica a doghe con palo di sostegno centrale con 14 doghe da 65mm in betulla ▷ La rete costituisce il telaio portante del letto
▶ Including an orthopedic staves bed frame with double central support and fourteen 65 mm birchen staves
▷ The bed frame is also the main frame of the bed



Secret Box®
▷ Include rete ortopedica a doghe con doppio palo di sostegno centrale con doghe 14mm in betulla
▷ Sistema brevettato Secret Box® con cassetto scorrevole
▷ Altezza interna contenitore cm 15
▷ Sistema di apertura tradizionale con molle a gas
▶ Includes orthopedic slatted bedstead with double central support pale with 14mm birch slats.
▷ Secret Box® patented system with sliding drawer.
▷ Internal container height 15 cm.
▷ Traditional opening system with gas springs.



Sfoderabilità Removable cover
▷ Quasi tutti i letti della nostra collezione prevedono il rivestimento tessile completamente sfoderabile
▷ Puoi facilmente riconoscerli nelle pagine del catalogo quando vedi questo simbolo nella relativa scheda tecnica
▶ Nearly all the beds of our collection have a completely removable cover
▷ You can recognize them in this catalogue by this symbol near the technical features

Bob Capitonné

design **Noctis**
Modello registrato/
Registered design



↗ Non sfoderabile
↗ Disponibile solo in pelle,
ecopelle e tessuti antimacchia
↗ Nelle Larghezze King, 180, 160,
Queen, 150, 140, 120, Twin, 90

↗ Non removable cover
↗ Only available in leather,
e-leather and dirt-proof fabrics
↗ Bed sizes available: King, 180, 160,
Queen, 150, 140, 120, Twin, 90

Varianti/ Version

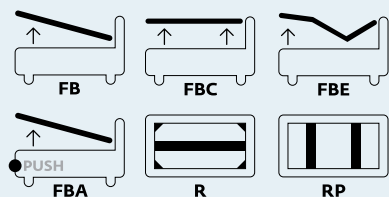

I disegni tecnici fanno riferimento al letto fornito con piedi standard. Al variare dei piedi variano anche l'altezza complessiva del letto e il piano d'appoggio del materasso. The production drawings are referred to the bed with standard feet. Any foot change will also imply a change of the height and of the mattress base.

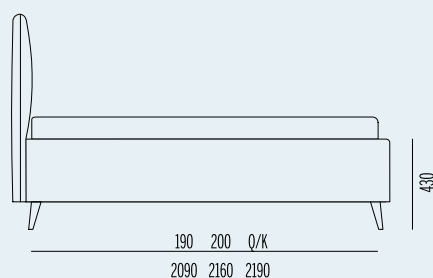
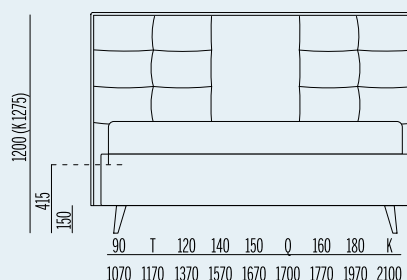

Folding box®

► Include rete ortopedica a doghe con doppio palo di sostegno centrale con 14 doghe in betulla da 65mm ► Sistema fondo brevettato Folding box® ► Altezza fascia contenitore h 27 cm ► Sistema di apertura tradizionale con molle a gas ► Including an orthopedic staves bed frame with double central support and fourteen 65 mm birchen staves ► Patented Folding box® bottom system for an easy cleaning of the storage area ► External height of the storage area: 27 cm ► Traditional opening system



Folding box® comfort

► Include rete ortopedica a doghe con doppio palo di sostegno centrale con 14 doghe in betulla da 65mm ► Sistema fondo brevettato Folding box® ► Altezza fascia contenitore h 27 cm ► Sistema di apertura comfort a rete parallela ► Including an orthopedic staves bed frame with double central support and fourteen 65 mm birchen staves ► Patented Folding box® bottom system for an easy cleaning of the storage area ► External height of the storage area: 27 cm ► Comfort parallel frame opening system



Folding box® automatic

► Include rete ortopedica a doghe con doppio palo di sostegno centrale con 14 doghe da 65 mm in betulla ► Sistema fondo brevettato Folding box® ► Altezza fascia contenitore h 27 cm ► Sistema di apertura automatico a pulsante elettrico con alimentazione 24 v ► Fornito con trasformatore e sistemi di sicurezza ► Including an orthopedic staves bed frame with double central support and fourteen 65 mm birchen staves ► Patented Folding box® bottom system for an easy cleaning of the storage area ► External height of the storage area: 27 cm ► Automatic electromechanical opening system - 24V power ► Provided with transformer and safety equipment



Folding box® ergonomics

► Include rete ortopedica a doghe con movimentazione elettrica e ergonomica ► Sistema fondo brevettato Folding box® ► Altezza fascia contenitore h 27 cm con vano interno ridotto a causa dell'ingombro rete ► Sistema di apertura tradizionale con molle a gas ► Including an ergonomic staves bed frame ► Patented Folding box® bottom system for an easy cleaning of the storage area ► External height of the storage area: 27 cm ► traditional opening system ► The storage area is reduced due to the different bed frame transformer and safety equipment



Ring pfi

► Non include la rete ► Predisposizione per rete in appoggio su barre trasversali (nr.2) ► Piano di appoggio rete regolabile su 4 livelli incassati di h 1 - 95 mm, h 2 - 120 mm h 3 - 145 mm, h 4 - 170 mm rispetto al bordo del giroletto ► The bed frame is not included ► The lateral bars are preset for a bed frame (nr.2) ► The bearing surface is adjustable at 4 heights h 1 - 95 mm, h 2 - 120 mm h 3 - 145 mm, h 4 - 170 mm Referring to the bed frame



Ring

► Non include la rete ► Predisposizione per rete in appoggio su angolari e palo centrale longitudinale ► Piano di appoggio reteregolabile su 2 livelli incassati di h 1 - 60 mm h 2 - 125 mm rispetto al bordo del giroletto ► The bed frame is not included ► Angles and central bars are preset for a bed frame ► The bearing surface is adjustable at 2 heights h 1 - 60 mm h 2 - 125 mm referring to the bed frame

Bob Capitonné h 17

h
I 7



↗ Non sfoderabile
 ↗ Disponibile solo in pelle, ecopelle e tessuti antimacchia
 ↗ Nelle Larghezze: King, 180, 160, Queen, 150, 140, 120, Twin, 90

↗ Non removable cover
 ↗ Only available in leather, e-leather and dirt-proof fabrics
 ↗ Bed sizes available: King, 180, 160, Queen, 150, 140, 120, Twin, 90

Varianti/ Version

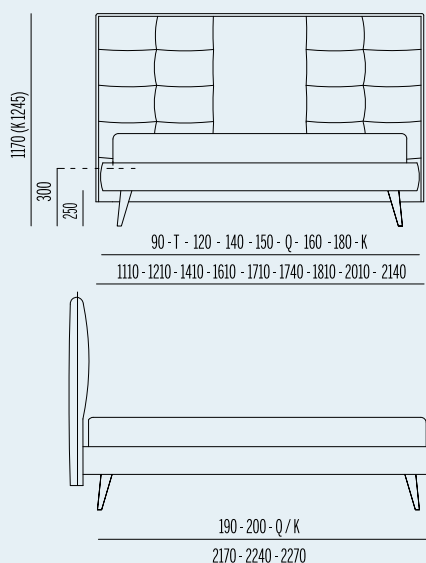
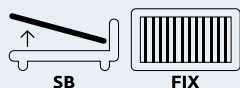

Fix
 ▷ Include rete ortopedica a doghe con palo di sostegno centrale con 14 doghe da 65mm in betulla ▷ La rete costituisce il telaio portante del letto
 ▶ Including an orthopedic staves bed frame with double central support and fourteen 65 mm birchen staves
 ▷ The bed frame is also the main frame of the bed



Secret Box®
 ▷ Include rete ortopedica a doghe con doppio pale di sostegno centrale con doghe 14mm in betulla
 ▷ Sistema brevettato Secret Box® con cassetto scorrevole
 ▷ Altezza interna contenitore cm 15
 ▷ Sistema di apertura tradizionale con molle a gas
 ▶ Includes orthopedic slatted bedstead with double central support pale with 14mm birch slats.
 ▷ Secret Box® patented system with sliding drawer.
 ▷ Internal container height 15 cm.
 ▷ Traditional opening system with gas springs.