

Buongiorno Notte Good Morning Night

The Project

2

Noctis[®]

**Io sono
Io sogno**

**I am
I dream**

The Project

Noctis[®]



Indotitis



Visita la nostra
azienda
Visit our company

**La tradizione Noctis si
conferma negli anni come
sinonimo di qualità e
in ogni sua finitura esalta
la superiorità del vero
Made in Italy.**

L'intero processo di creazione dei letti Noctis è così: dal design sino all'ultimo sguardo prima di chiudere la spedizione che arriverà a casa vostra. Siamo orgogliosi di essere nel cuore dell'Italia, nel cuore delle Marche, perché questo ci fa eredi di una tradizione artigiana che da anni Noctis fa crescere con tecnologie all'avanguardia, continuando a ideare sistemi di realizzazione innovativi e prodotti brevettati. Depositare il design di un letto o un sistema significa proteggere le vostre scelte, facendoci garanti di un servizio totale, che risponde agli standard e alle certificazioni più severi. La cura e la grande passione per i dettagli e la qualità fanno dei nostri prodotti un esempio di una cultura artigianale applicata all'industrial design, coniugando armoniosamente aspetti tecnologici, estetici ed emozionali. I nostri letti sono sempre espressione di una cultura che si nutre del mondo, dei suoi colori, delle forme e delle sue suggestioni, e le traduce in oggetti belli, confortevoli, funzionali ed accessibili a tutti. Perché il bello va vissuto ogni giorno... e ogni notte.

**Un sogno?
Forse, ma noi siamo
veri sognatori.**

**We devoted ourselves to
the creation of a top quality
product that celebrates
the excellence of the real
Made in Italy in every
detail and feature.**

This is a Noctis bed: beginning with the design up to the last glimpse and till the package that will bring it to your home. We are so proud of being in the heart of Italy, and in the heart of the Marche region, as this is the place where we could grow up breathing the craftsmen tradition: a legacy that Noctis is enriching with the leading technologies, inventing new production systems and patenting new creations. Patenting the design of a bed or parts of its mechanism means protecting your choices, answering for a total service that suits the highest quality standards. Our care and passion for details and quality make out of our products an outstanding example of the craftsmen tradition applied to industrial design, harmonizing technology, aesthetics and emotions. It is the expression of a culture that finds its nourishment in the World, in its colours, its shapes and its awesomeness and joins them all in beautiful, comfortable and affordable objects. We think that beauty must be present in everyday life... and in every night.

**Is this just a dream?
Maybe....
for real dreamers.**

Box plus

Il sistema contenitore **Box Plus** caratterizza i prodotti Noctis da sempre. La solida struttura in ferro perimetrale che collega tra loro testata, fascioni e pediera rende estremamente solido e robusto il vano contenitore. I pannelli di fondo marchiati Noctis personalizzano il prodotto e sono realizzati in HDF, oggi aumentati di spessore, per garantire solidità e durata nel tempo. Il **Box Plus Noctis** è caratterizzato anche dalla sua rete standard con doppio palo di sostegno centrale a 14 doghe e dal sistema di aggancio sferico del meccanismo alzante, una sicurezza in più per un corretto montaggio ed utilizzo.

Box plus storage system has always characterized Noctis. The solid steel perimeter structure which links together the headboard, sides and footboard makes storage extremely strong. Noctis branded bottom panels personalize the product. They are realized in HDF, actually thickness increased to ensure strength and long-lasting durability. **Box Plus Noctis** is also characterized by its standard bedstead with double supporting central pole, 14 slats, and spherical hooking system of lifting mechanism, for additional security and a correct assembly and utilization.

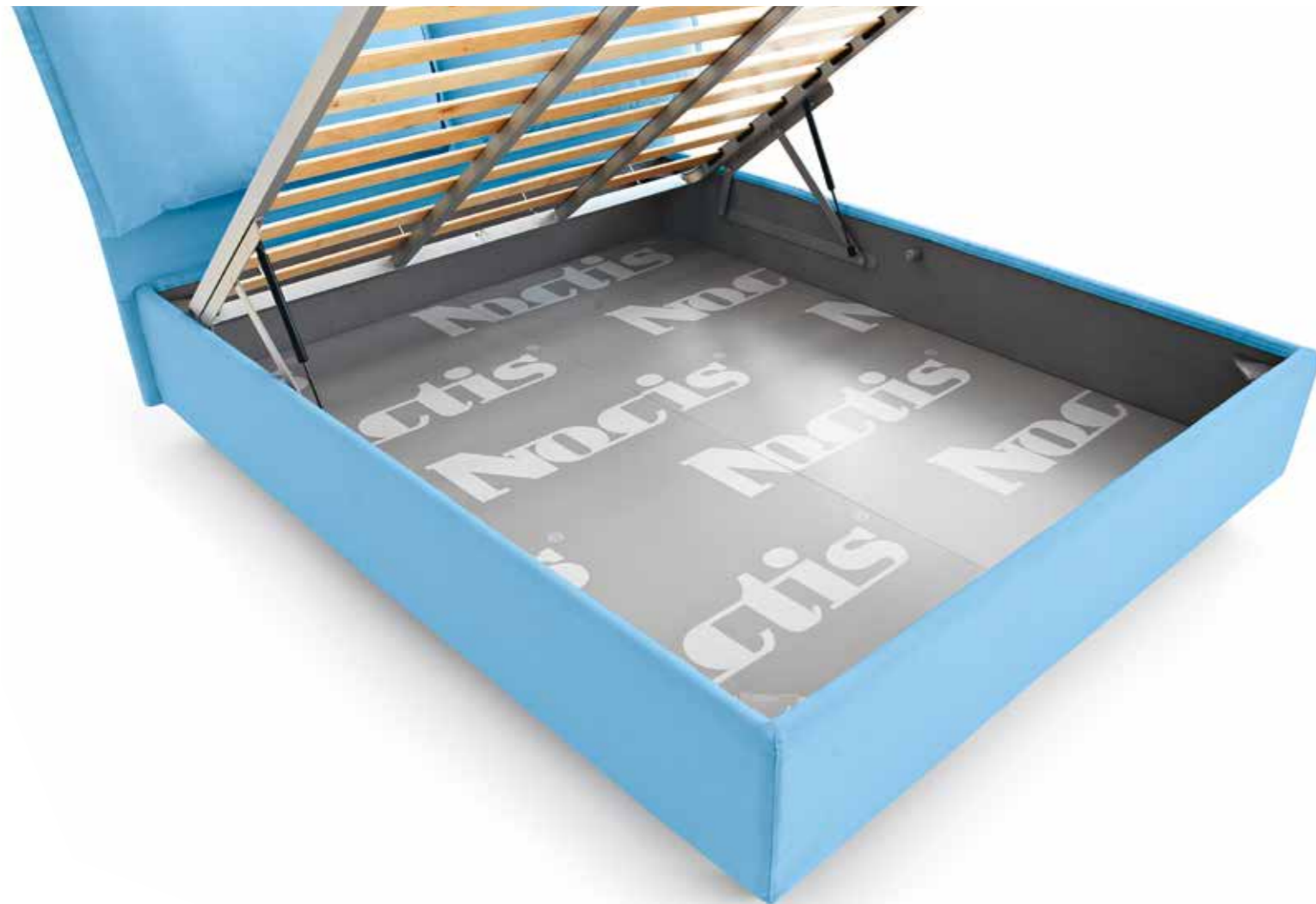

Caratteristiche tecniche/ Features technical:

- Sistema box con telaio perimetrale in acciaio
- Fondi marchiati Noctis
- Copriangolari in polipropilene
- Pistone agganciato sferico
- Include rete ortopedica a doghe con doppio palo di sostegno centrale con 14 doghe in betulla da 65mm
- Box system with steel perimeter frame
- Noctis branded bottom panels
- Polypropylene angular covers
- Spherical hooked piston
- Including an orthopedic staves bed frame with double central support and fourteen 65 mm birchen staves



Varianti Versions

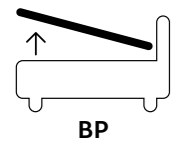

BP



Box plus

- ▷ Include rete ortopedica a doghe con doppio palo di sostegno centrale con 14 doghe in betulla da 65mm
- ▷ Sistema box con telaio perimetrale in acciaio
- ▷ Fondi marchiati Noctis
- ▷ Copriangolari in polipropilene
- ▷ Sistema di apertura tradizionale con molle a gas
- ▷ Including an orthopedic staves bed frame with double central support and fourteen 65 mm birchen staves
- ▷ Box system with steel perimeterframe
- ▷ Noctis branded bottom panels
- ▷ Olypropylene angular covers
- ▷ Spherical hooked piston
- ▷ Traditional opening system a gas

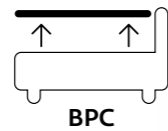

BPC



Box plus comfort

- ▷ Include rete ortopedica a doghe con doppio palo di sostegno centrale con 14 doghe in betulla da 65mm
- ▷ Sistema box con telaio perimetrale in acciaio
- ▷ Fondi marchiati Noctis
- ▷ Copriangolari in polipropilene
- ▷ Sistema di apertura comfort a rete parallela
- ▷ Including an orthopedic staves bed frame with double central support and fourteen 65 mm birchen staves
- ▷ Box system with steel perimeterframe
- ▷ Noctis branded bottom panels
- ▷ Olypropylene angular covers
- ▷ Comfort parallel frame opening system

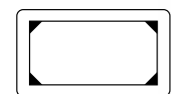

R14



Ring 014

- ▷ Non include la rete.
- ▷ Predisposizione per rete in appoggio su angolari
- ▷ Piano di appoggio rete regolabile su 2 livelli incassati di h 1 - 60 mm h 2 - 125 mm rispetto al bordo del giroletto
- ▷ Disponibile optional anche con palo centrale
- ▷ The bed frame is not included
- ▷ Angles and central bars are preset for a bed frame
- ▷ The bearing surface is adjustable at 2 heights h 1 - 60 mm h 2 - 125 mm referring to the bed frame
- ▷ Available optional even with central pole

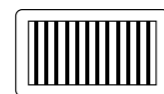

FIX



Fix

- ▷ Include rete ortopedica a doghe con palo di sostegno centrale con 14 doghe da 65mm in betulla
- ▷ La rete costituisce il telaio portante del letto
- ▷ Including an orthopedic staves bed frame with double central support and fourteen 65 mm birchen staves
- ▷ The bed frame is also the main frame of the bed

Sfoderabilità Removable cover

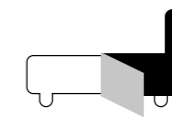

Sfoderabilità

- ▷ Quasi tutti i letti della nostra collezione prevedono il rivestimento tessile completamente sfoderabile
- ▷ Puoi facilmente riconoscerli nelle pagine del catalogo quando vedi questo simbolo nella relativa scheda tecnica

Removable cover

- ▷ Nearly all the beds of our collection have a completely removable cover
- ▷ You can recognize them in this catalogue by this symbol near the technical features

Box h30

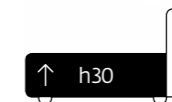

H30

- ▷ Tutti i box contenitore dei letti di questa collezione hanno altezza 25 cm fatta eccezione di alcuni che misurano 30 cm, puoi facilmente riconoscerli quando vedi questo simbolo nella relativa scheda tecnica.

- ▷ Standard storage boxes of this collection are cm 25 high except for those cm30 identified with this symbol you can easily verify in the technical sheet.

I nostri prodotti possono essere realizzati in differenti configurazioni tutte quante espressione della grande versatilità della nostra collezione e dell'attenzione che Noctis riserva ai propri clienti.

Every Noctis bed is produced in many different versions. Each of them is an expression of the versatility of our collection and of the care that Noctis takes for the dreamers (that) choosing its beds.



Indice Index

Moody	16	Guru	122
		Guru H10	
Seven	24	Duck	132
Fiordaliso	34	Dizzy	140
		Dizzy High	
Tango S	44	Bridge	148
Giulia	54	Paris	158
		Paris L	
Cefalù	62	Dream Modern	166
		Dream Modern H10	
Portofino	74	Dream Capitonè	
Vera Advance Voulant	84	Jazz	176
Vera Advance Air		Jazz H10	
Vera Advance X		Sommier	184
Vera Advance		Sommier H10	
Manuel	98	Zico	192
Smart	106		
Me	114		
Me L			

Moody

design Noctis



Un design elegante, morbido
con raffinati dettagli
e giochi di contrasto.

—
An elegant, soft design
with refined details
and games of contrast
—

Moody 160x200
Box plus
Penelope 20 cat. C
Coordinato biancheria
Bedlinen 5701
Piede
Moody metallo bianco

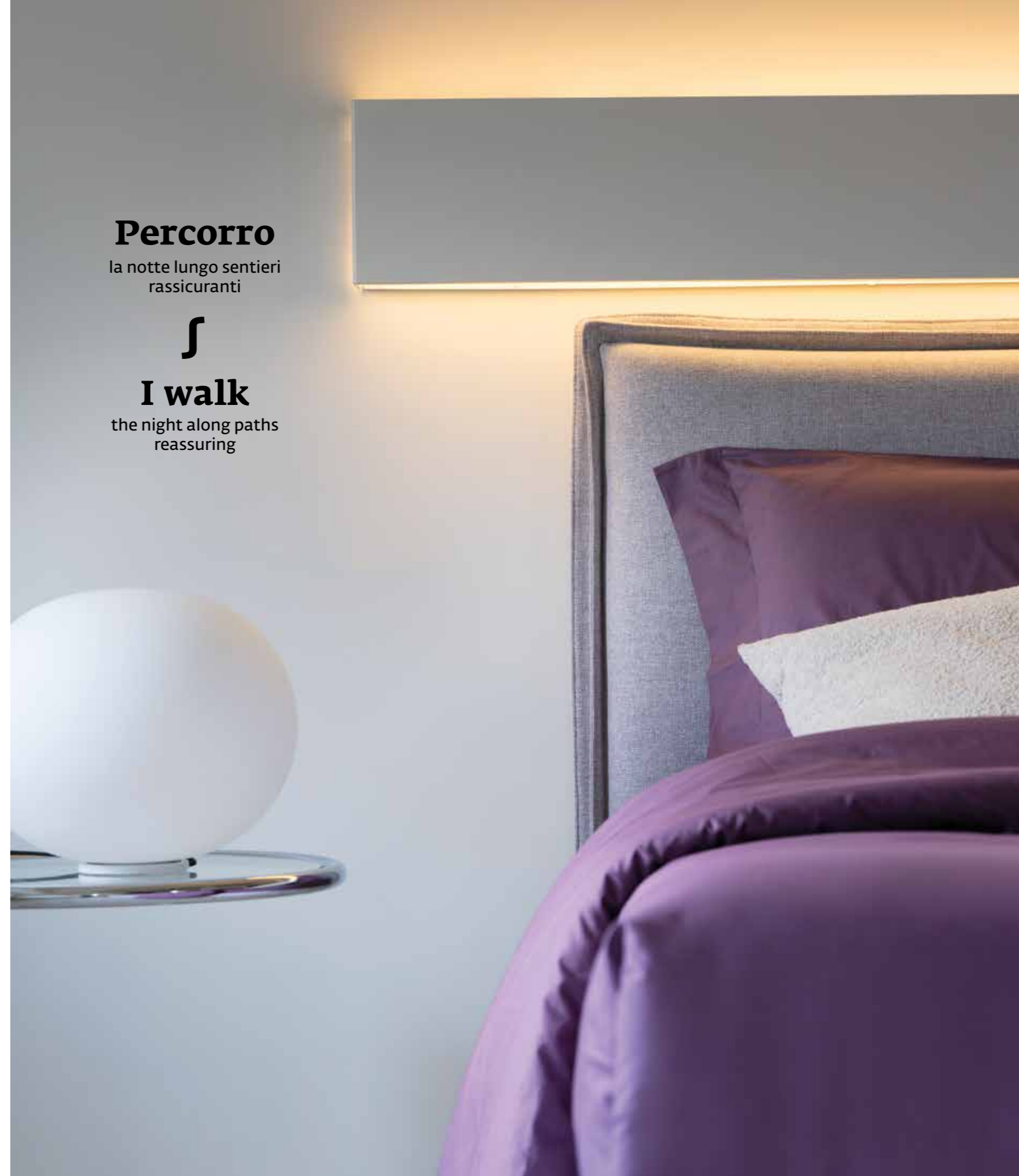

Percorro

la notte lungo sentieri
rassicuranti

∫

I walk

the night along paths
reassuring



Un design elegante, morbido
con raffinati dettagli
e giochi di contrasto.

—
An elegant, soft design
with refined details
and games of contrast
—



Moody

Grande capienza del contenitore, semplicità delle linee, minimo ingombro. Moody è il letto che sa adattarsi ad ogni occasione. Disponibile in tutti i tessuti del nostro campionario e anche in versione bicolore. È realizzato in soffici schiumati che lo rendono morbido al tatto in ogni suo punto.

Large storage capacity, simplicity of lines, and minimum overall dimensions. Moody is the bed which can be adapted to each situation. Available in all fabrics of our samples collection and also in a bicolour version. It is realized in soft polyurethane foam which makes Moody smooth to the touch in point any.



Una palette di colori neutri
per un'atmosfera intima
e accogliente, ideale per ogni
stile d'arredo, dal classico al minimal.

—
A neutral color palette
for an intimate atmosphere
and welcoming, ideal for every
furnishing style, from classic to minimal.
—

Moody 160x200
Box plus
Penelope og/
Bordino Penelope 15 cat. C
Coordinato biancheria
Bedlinen 2050
Piede Moody metallo cromo

Moody 90



Verde sottobosco, blu ceruleo
per un'ambiente vivace
e pieno di energia.

—
Forest Green, Cerulean Blue
for a lively environment
and full of energy.

Moody 90x180
Box plus
Aida 24 cat. C
Coordinato biancheria
Bedlinen 2560
Piede Moody metallo bianco

Moody

↳ Disponibile in tutti i tessuti del nostro campionario, versione bicolor in tutti i tessuti della cat. C ↳ Nelle Larghezze King, 180, 160, Queen, 150, 140, 120, Twin, 90
↳ Sfoderabile previo smontaggio della testiera

↳ Available in all the fabrics of our catalogue, bicolor version in all the fabrics of the cat. C ↳ Bed sizes available: King, 180, 160, Queen, 150, 140, 120, Twin, 90
↳ Removable cover After removing the headboard

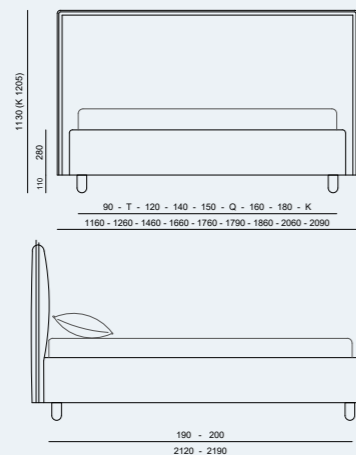
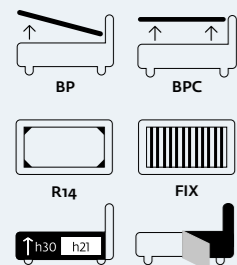

I disegni tecnici fanno riferimento al letto fornito con piedi standard.
Al variare dei piedi variano anche l'altezza complessiva del letto e il piano d'appoggio del materasso. The production drawings are referred to the bed with standard feet. Any foot change will also imply a change of the height and of the mattress base.

Seven

design Noctis

accogliente

tutto il comfort
che desideri



attractive

all the comfort
you wish



Seven 160x200
Box plus
Aida 20 cat. C
Cover testata
Bordino Aida 20 cat. C
Cerniera grigia 154
Coordinato biancheria
Bedlinen 1465
Piede obliquo natural hno



Un design innovativo
sorprendente
con pratici giochi di colore

—
An innovative design
amazing
with practical plays of color
—

Seven 160x200
Box plus
Aida 20 cat. C
Cover testata Aida 20 cat. C
Bordino Aida 18 cat. C
Cerniera grigia 154
Coordinato biancheria Bedlinen 1465
Piede obliquo natural h110



I dettagli fanno
la differenza.

—
Details do
the difference.
—



Seven 160x200
Box plus
Brando o8 cat. B
Cover testata Brando o8 cat. B
Cerniera verde 875
Coordinato biancheria
Bedlinen 1416
Piede obliquo natural h110

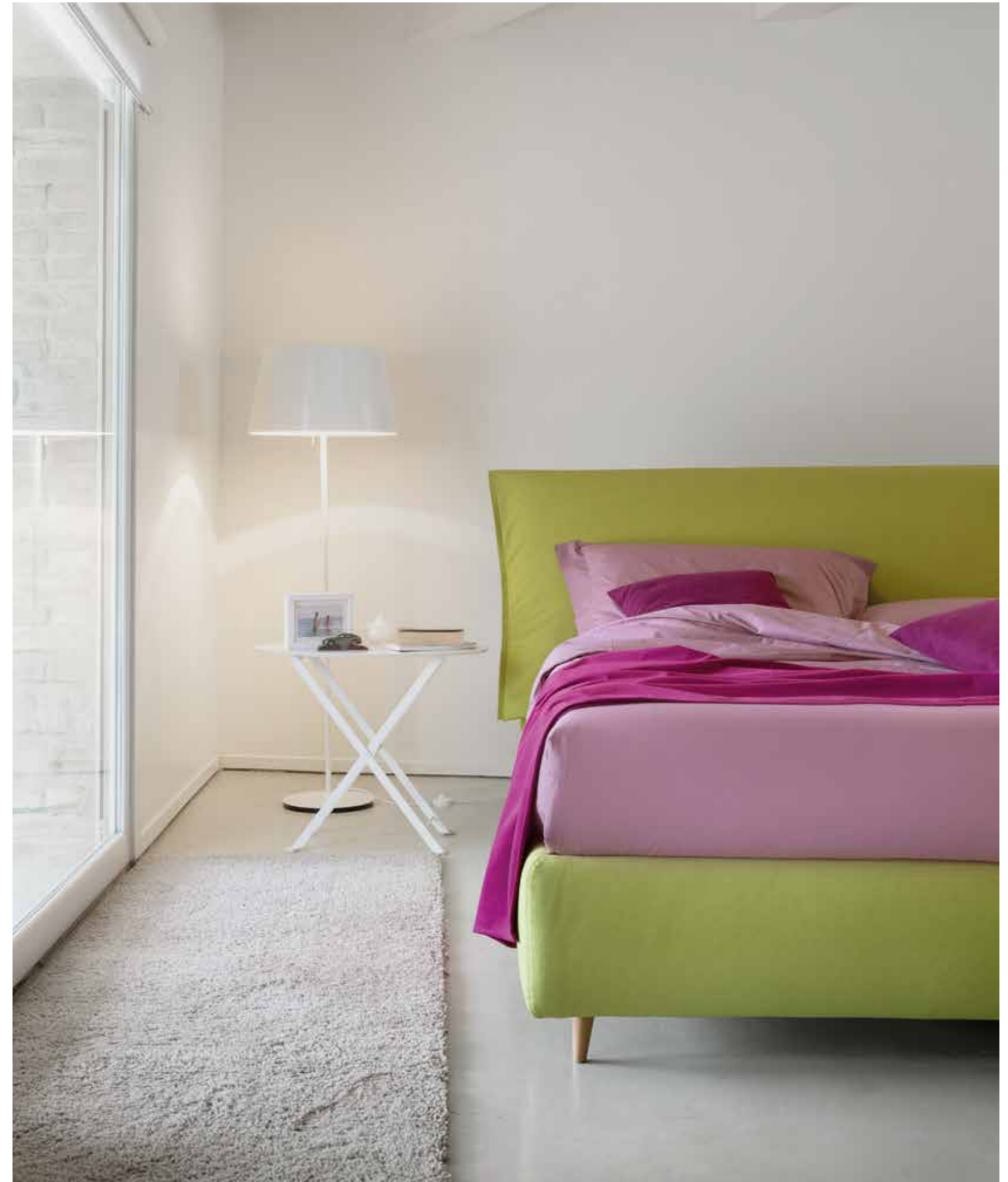



**Una testata
che avvolge
per caldi
abbracci.**

—
A warhead
which envelops
for warm
Hugs.

Seven

La testata del letto Seven è avvolta da una cover disponibile sia in tinta unita che in contrasto con la possibilità di scegliere il colore del bordino. La cover si trasforma in una morbida coperta grazie alle due cerniere laterali. Il rivestimento è completamente sfoderabile.

The headboard of the Seven bed it is wrapped in a cover available both in solid color and in contrast with the possibility to choose the colour of the border. The cover transforms into a soft blanket thanks to the two zips lateral. The lining it is completely removable.



1



2



3

**Con un semplice
movimento della zip
la cover testata
diventa coperta.**

—
With a simple
zip movement
header cover
becomes covered.



Seven 90



Seven 90x190
Box plus
Aida 01 cat. C
Cover testata Aida 19 cat. C
Bordino Aida 01 cat. C
Coordinato biancheria
Bedlinen 4092
Cerniera blu 040
Piede P2 natural h10



Seven 90x190
Box plus
Aida 01 cat. C
Cover testata Aida 11 cat. C
Bordino Aida 01 cat. C
Cerniera rosa 005
Coordinato biancheria Bedlinen 4092
Piede P2 natural h10

intercambiabile

un letto smart con cromie
fresco e solare



interchangeable

a smart bed with colours
fresh and sunny



Seven 90x190
Box plus
Aida 01 cat. C
Coordinato biancheria
Bedlinen 4092
Piede P2 natural h10

Seven

↳ Disponibile in tutti i tessuti del nostro campionario ↳ Nelle Larghezze King, 180, 160, Queen, 150, 140, 120, Twin, 90

↳ Available in all the fabrics of our catalogue ↳ Bed sizes available: King, 180, 160, Queen, 150, 140, 120, Twin, 90

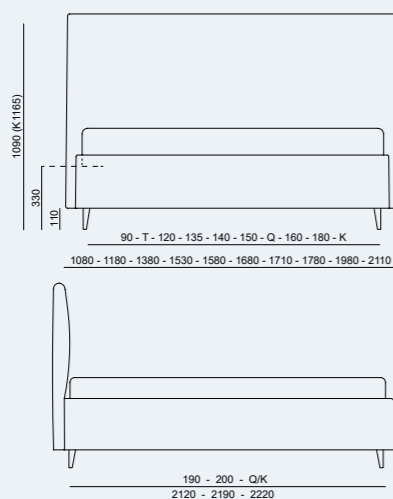
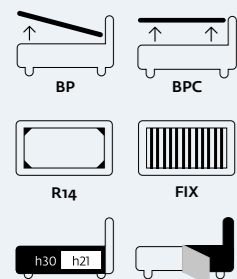

I disegni tecnici fanno riferimento al letto fornito con piedi standard. Al variare dei piedi variano anche l'altezza complessiva del letto e il piano d'appoggio del materasso. The production drawings are referred to the bed with standard feet. Any foot change will also imply a change of the height and of the mattress base.

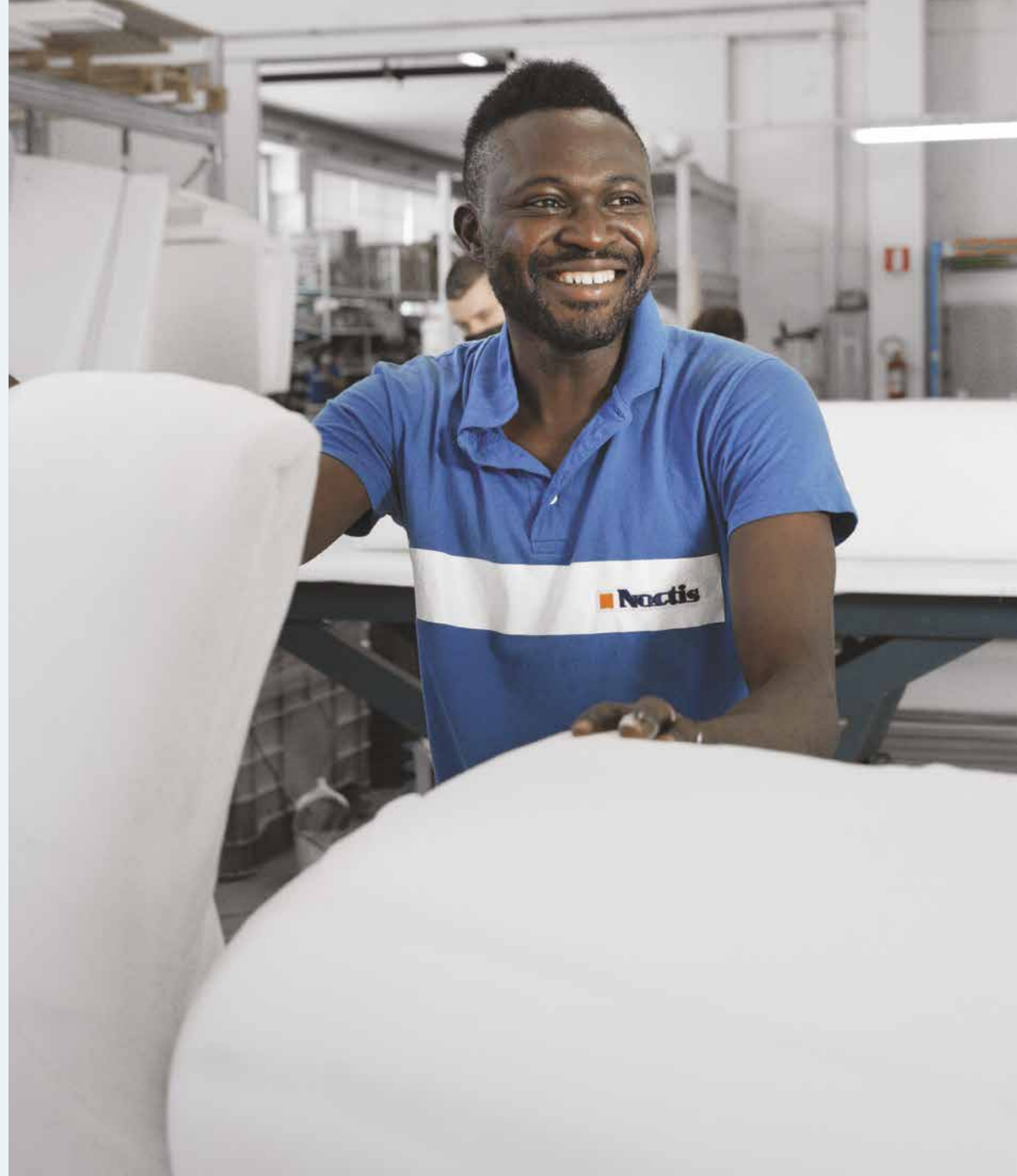

Fiordaliso

design Noctis

Linee romantiche
per notti di eterna primavera.
Ritrovo armonia fra le curve
delle nostre anime.

—
Romantic lines for nights
of eternal spring.
I find harmony between
the curves of our souls.
—

Mi ritrovo

adagiato fra le curve
dei miei ricordi

∫

I find myself

living among the curves
of my memories





Accolgo

tutti i profumi della notte
per farne sogno



I welcome

all the scents of the night
to make them dream



Fiordaliso 160
Penelope O1, Cat.C
Piedi P1 natural
Foot P1 natural
h 110



Fiordaliso 160
Panama 570, Cat.C
Piedi P1 natural
Foot P1 natural
h 110



Fiordaliso

Fiordaliso è un classico senza tempo. E' realizzabile in tutti i tessuti del campionario ma non in pelli sintetiche e naturali. Completamente sfoderabile è particolarmente adatto per arredamenti in stile country o Shabby Chic. Il rivestimento a mantovana del giroletto cela con discrezione l'ampio vano contenitore che si può allestire in differenti conformazioni.

Cornflower is a timeless classic. It can be made in all the fabrics of the sample but not in synthetic and natural leathers. Completely removable, it is particularly suitable for country or Shabby Chic style furnishings. The valance covering of the bed frame discreetly conceals the large storage compartment that can be set up in different configurations.



Fiordaliso 160
Panama 117, Cat.C
Piedi P1 natural
Foot P1 natural
h 110



Mi sveglio

fra i rami di una stagione
che continua a stupirmi



I wake up

among the branches of a season
which continues to amaze me



Fiordaliso 160
Penelope 01, Cat. C
Piedi P1 natural
Foot P1 natural
h 110

Fiordaliso

↳ Disponibile in tutti i tessuti del nostro campionario, tranne pelle ed ecopelle
↳ Nelle Larghezze King, 180, 160, Queen, 150, 140

↳ Available in all the fabrics of our catalogue except for leather and e-leather
↳ Bed sizes available: King, 180, 160, Queen, 150, 140

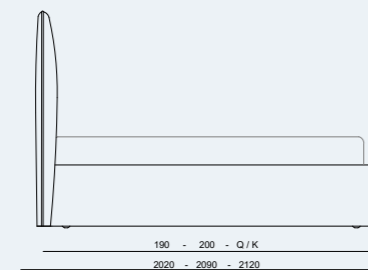
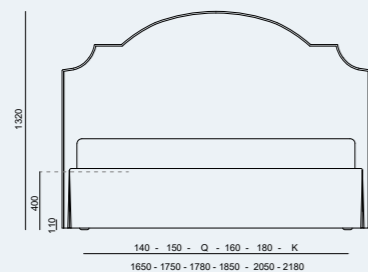
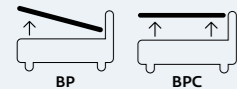

I disegni tecnici fanno riferimento al letto fornito con piedi standard.
Al variare dei piedi variano anche l'altezza complessiva del letto e il piano d'appoggio del materasso. The production drawings are referred to the bed with standard feet. Any foot change will also imply a change of the height and of the mattress base.



Tango S

design Noctis

Elegante, pragmatico
e pratico anche
in versione contenitore.

Elegant, pragmatic
and practical also with
storage container base.



→
Tango S 160
Smile 9820, Cat.C
Piedi P1 wengè
Wengè foot P1
h 110

morbido
e mai invadente



soft
and never intrusive





Tango S

Tango S è un letto che non tramonta mai. I due soffici cuscini della testata leggermente più stretti rispetto al pannello della testiera sembrano incastonati alla perfezione nei volumi del letto. In cotone, in velluto, in similpelle Tango S conserva sempre il suo fascino. Nelle misure singole è realizzato con un solo cuscino. Disponibile anche con sistema contenitore.

Tango S is a bed that never sets. The two soft cushions of the headboard slightly narrower than the headboard panel seem perfectly set in the volumes of the bed. Cotton, velvet, imitation leather Tango S always retains its charm. In single sizes it is made with a single cushion. Also available with storage system.



→
Tango S 160
Smile 9820, Cat.C
Piedi P1 wengè
Wengè foot P1
h 110



←
Tango S 160
Mover black, Cat.C
Piedi P1 wengè
Wengè foot P1
h 110



Sogno

di scaldare cuori solitari
per farne abbracci



I dream

of warming lonely hearts
to make hugs



Tango S

↳ Disponibile in tutti i tessuti del nostro campionario ↳ Nelle Larghezze King, 180, 160, Queen, 150, 140, 120, Twin, 90

↳ Available in all the fabrics of our catalogue ↳ Bed sizes available: King, 180, 160, Queen, 150, 140, 120, Twin, 90

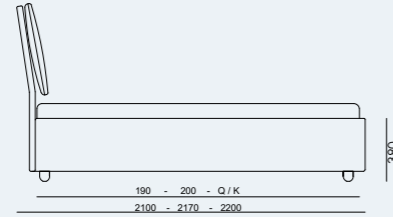
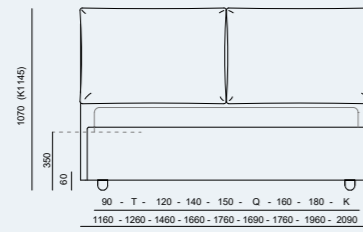
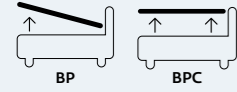

I disegni tecnici fanno riferimento al letto fornito con piedi standard. Al variare dei piedi variano anche l'altezza complessiva del letto e il piano d'appoggio del materasso. The production drawings are referred to the bed with standard feet. Any foot change will also imply a change of the height and of the mattress base.



Giulia

design Noctis

Incontro

punti nascosti e mi sorprendo
fra le emozioni



Meeting

hidden points and I feel surprised
between emotions



Elegante Giulia,
per veri sognatori.

—
Elegant Giulia,
to real dreamers

Giulia 160
Mover chamois, Cat.C
Piedi P1 natural
Natural foot P1
h 110





Giulia

Giulia. Mai prima d'ora la maestria dei nostri tappezzieri e le tecniche di produzione industriale si erano incontrate così bene. Un letto dal grande valore percepito e dalla grande qualità grazie alle cuciture a quadri della testata abbinate alla morbida ovatta dell'interno. Soffice ma allo stesso tempo rigoroso. Contenuto negli ingombri ma di grande impatto. Disponibile anche in versione singola.

Giulia. Never before the craftsmanship of our upholsterers and industrial production techniques has met so well. A bed of great perceived value and great quality thanks to the checked seams of the headboard combined with the soft wadding inside. Soft but at the same time rigorous. Contained in dimensions but of great impact. Also available in single version.



Giulia 90
Silvia 11, Cat. C
Piedi P1 wengè
Wengè foot P1
h 110



Giulia 160
Mover chamois, Cat. C
Piedi P2 natural
Natural foot P1
h 110



Giulia 160
Silvia 02, Cat. C
Piedi P2 natural
Natural foot P1
h 110

Giulia

↳ Disponibile in tutti i tessuti del nostro campionario e nei 4 abbinamenti bicolore in silvia e mover ↳ Nelle Larghezze King, 180, 160, Queen, 150, 140, 120, Twin, 90

↳ Available in all the fabrics of our catalogue and 4 two-tone combinations in silvia and mover ↳ Bed sizes available: King, 180, 160, Queen, 150, 140, 120, Twin, 90

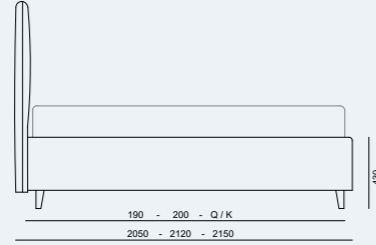
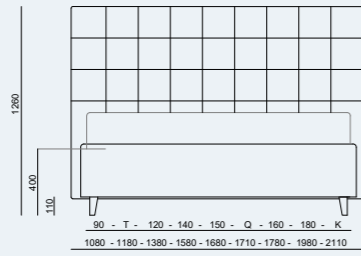
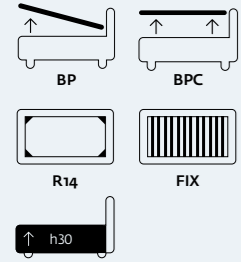

I disegni tecnici fanno riferimento al letto fornito con piedi standard. Al variare dei piedi variano anche l'altezza complessiva del letto e il piano d'appoggio del materasso. The production drawings are referred to the bed with standard feet. Any foot change will also imply a change of the height and of the mattress base.



Cefalù

Un morbido rifugio.
Perchè 'Tenera è la notte'

A soft shelter. Because
'Tender is the night'



→
Cefalù® 160x200
Box Plus
Maratea 401, cat. B
Piede bianco obliquo
White slanted foot

Bedlinen 0000
Cuscini d'arredo
Furniture cushions
2: 50x50
Dis.1437, col.20
2: 50x50
Cervia 401, cat. B

design **Piero Priori**

Modello registrato
Registered design

Descrivo

l'eleganza con una quiete
e serena morbidezza.



I describe

elegance with a still and
peaceful softness.

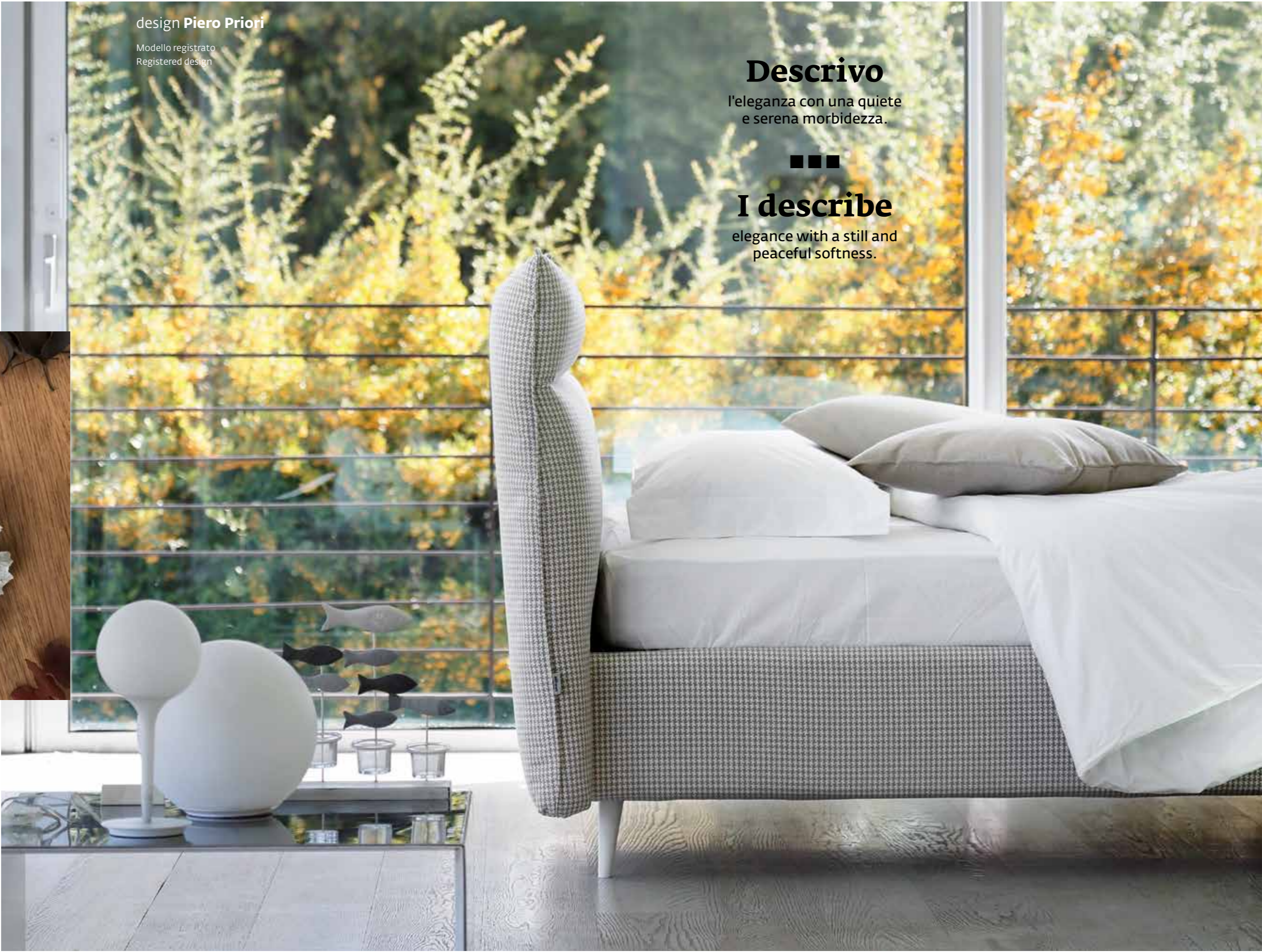

Assolvo

alle mie funzioni, sottovoce
con dolcezza

§

Absolve

to my duties, in a whisper
with sweetness



CHIC & SOFT

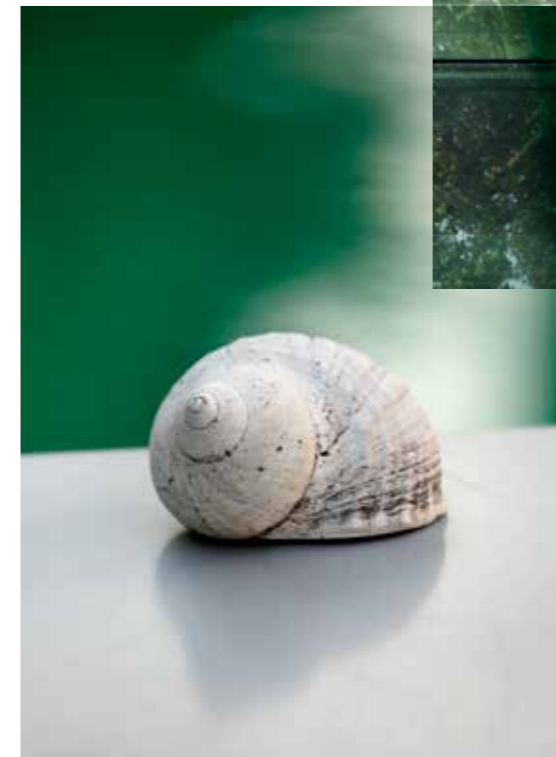
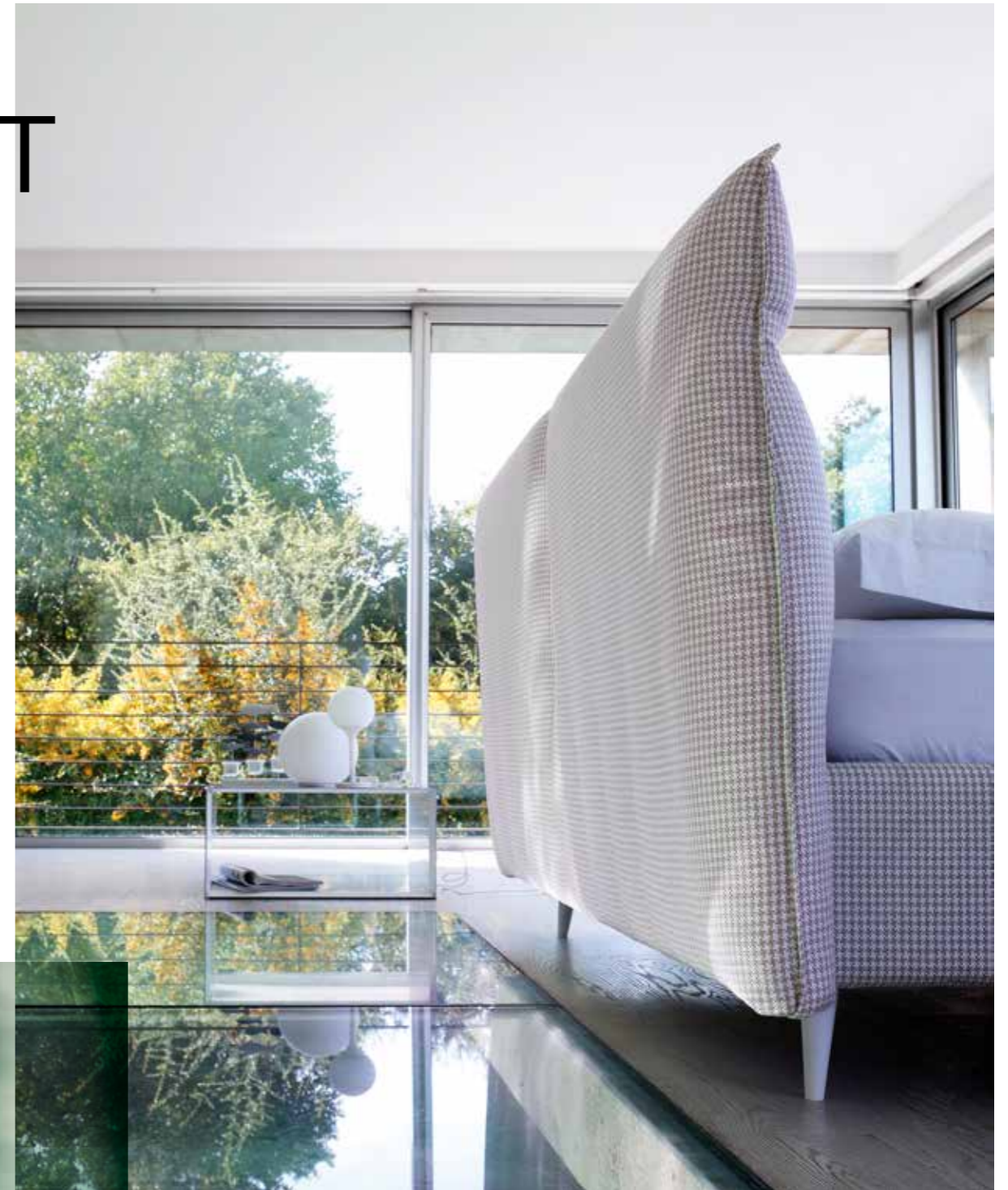

Cefalù® 160x200
Box Plus
Maratea 401, cat. B
Piede bianco obliquo
White slanted foot

Bedlinen 0000
Cuscini d'arredo
Furniture cushions
2: 50x50
Dis.1437, col.20
2: 50x50
Cervia 401, cat. B

Mi presto

a vari abiti, dal sofisticato
pied de poule ad
eleganti tonalità
di grigi.



I'll see you soon

to various dresses, from the
sophisticated pied de poule
to elegant shades
of grey.



Cefalù® nasce nella collezione The Projects arricchendola di nuove linee. La soffice e avvolgente testata trapuntata è realizzabile in tutti i tessuti che compongono l'ampia gamma delle produzioni Noctis. È un letto tessile di eleganza minimale, dalla struttura morbida e dal carattere mite. Una capiente base contenitore offre solidità. Assolve alle sue funzioni sottovoce, con dolcezza, per lasciarvi il piacere del pieno abbandono alle trame dei vostri sogni.

Cefalù® is born in The Projects collection, enhancing it with new lines. The soft and embracing quilted headboard can be made in any of the fabrics that make up the wide range of Noctis products. It's a textile bed of minimal elegance, with a soft structure and a mild temper. A large container basis offers solidity. Cefalù softly and gently fulfils its functions, to leave you the pleasure of full abandonment to the plots of your dreams.



GLAM & COOL

Cefalù® 160x200
Box Plus
Brando 29, cat. B
Piede alluminio obliquo
Oblique aluminum foot

Bedlinen 9050
Cuscini d'arredo
Furniture cushions
2: 50x50
Dis.1436, col.11
2: 50x50
Dis.1437, col.21



Cefalù

Cefalù

- ↳ Non sfoderabile
- ↳ Disponibile in tutti i tessuti del nostro campionario
- ↳ Disponibile in 9 larghezze: King (193), 180, 160, Queen (153), 150, 140, 120, Twin (100), 90

- ↳ Not removable cover
- ↳ Available in all the fabrics of our catalogue
- ↳ Bed is available in 9 widths: King (193), 180, 160, Queen (153), 150, 140, 120, Twin (100), 90

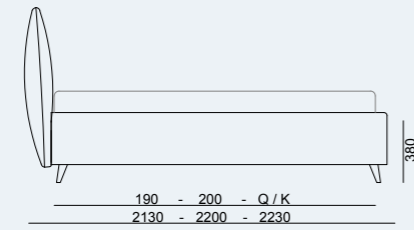
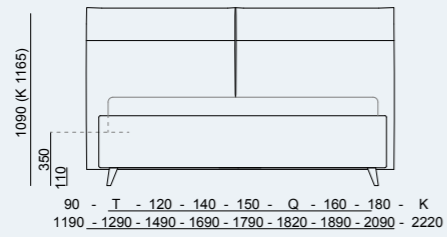
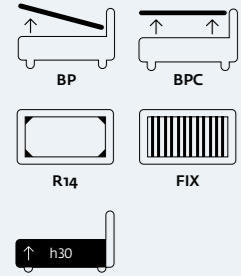

I disegni tecnici fanno riferimento al letto fornito con piedi standard. Al variare dei piedi variano anche l'altezza complessiva del letto e il piano d'appoggio del materasso. The production drawings are referred to the bed with standard feet. Any foot change will also imply a change of the height and of the mattress base.

Portofino

design Noctis



Raffinata morbidezza
racchiusa in volumi
contenuti.
—
Refined smoothness
enclosed in volumes
content.
—

→
Portofino
Silvia 24, cat. C
piede P2 natural
P2 natural foot
H 60



Portofino

unico
ma mai sopra le righe



alone
never over the line



Portofino
Abbinamento 2,
combination 2
piede campana
bell foot
H 60



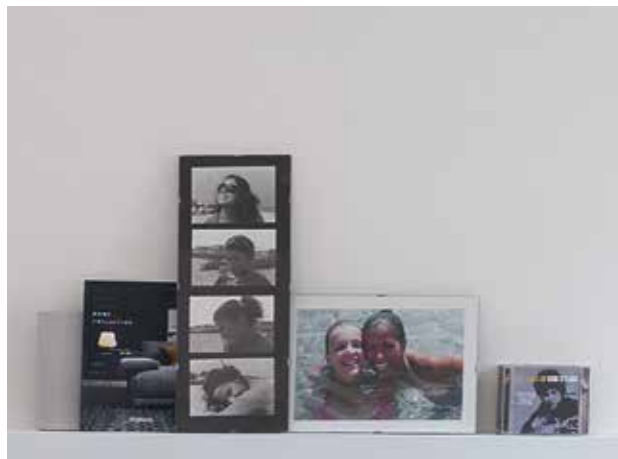

↑
Portofino
 Silvia 24, cat. C
 piede P2 natural
 P2 natural foot
 H 60

Portofino

L'originale testata di Portofino è caratterizzata dai due soffici cuscini realizzati in ovatta. Il leggero punto di trapunta centrale ne enfatizza l'effetto morbidezza mentre il rivestimento continuo tra cuscino e testata dona una rigorosa e piacevole pulizia di linee. Realizzabile in tinta unita o in quattro abbinamenti bicolore. In questo caso l'interno della testata è realizzato in colore a contrasto rispetto al rivestimento del letto.

The original Portofino headboard is characterized by two soft polyester filling cushions. The light central stitching emphasizes the effect of softness while the seamless cover, between cushion and headboard, gives a rigorous and pleasant cleanliness of the lines. Available in a plain color or in four bicolor options. In this case the inside of headboard's edge is realized in a contrasting color to the one of the entire bed.



Portofino
 Abbinamento 2,
 combination 2
 piede campana
 bell foot
 H 60

Sono disponibili 4 abbinamenti bicolore in ecopelle

There are 4 bi-color combinations in e-leather



Abb. 1
 Silvia 24
 Mover dk brown



Abb. 2
 Silvia 05
 Mover orchieda



Abb. 3
 Silvia 01
 Mover rye



Abb. 4
 Silvia 31
 Mover fiordaliso

morbido
e mai invadente



soft
and never intrusive



Portofino
Silvia 24, cat. C
piede P2 natural
P2 natural foot
H 60

Portofino

↳ Disponibile in tutti i tessuti del nostro campionario e nei 4 abbinamenti bicolore in silvia e mover ↳ Nelle Larghezze King, 180, 160, Queen, 150, 140, 120, Twin, 90

↳ Available in all the fabrics of our catalogue and 4 two-tone combinations in silvia and mover ↳ Bed sizes available: King, 180, 160, Queen, 150, 140, 120, Twin, 90

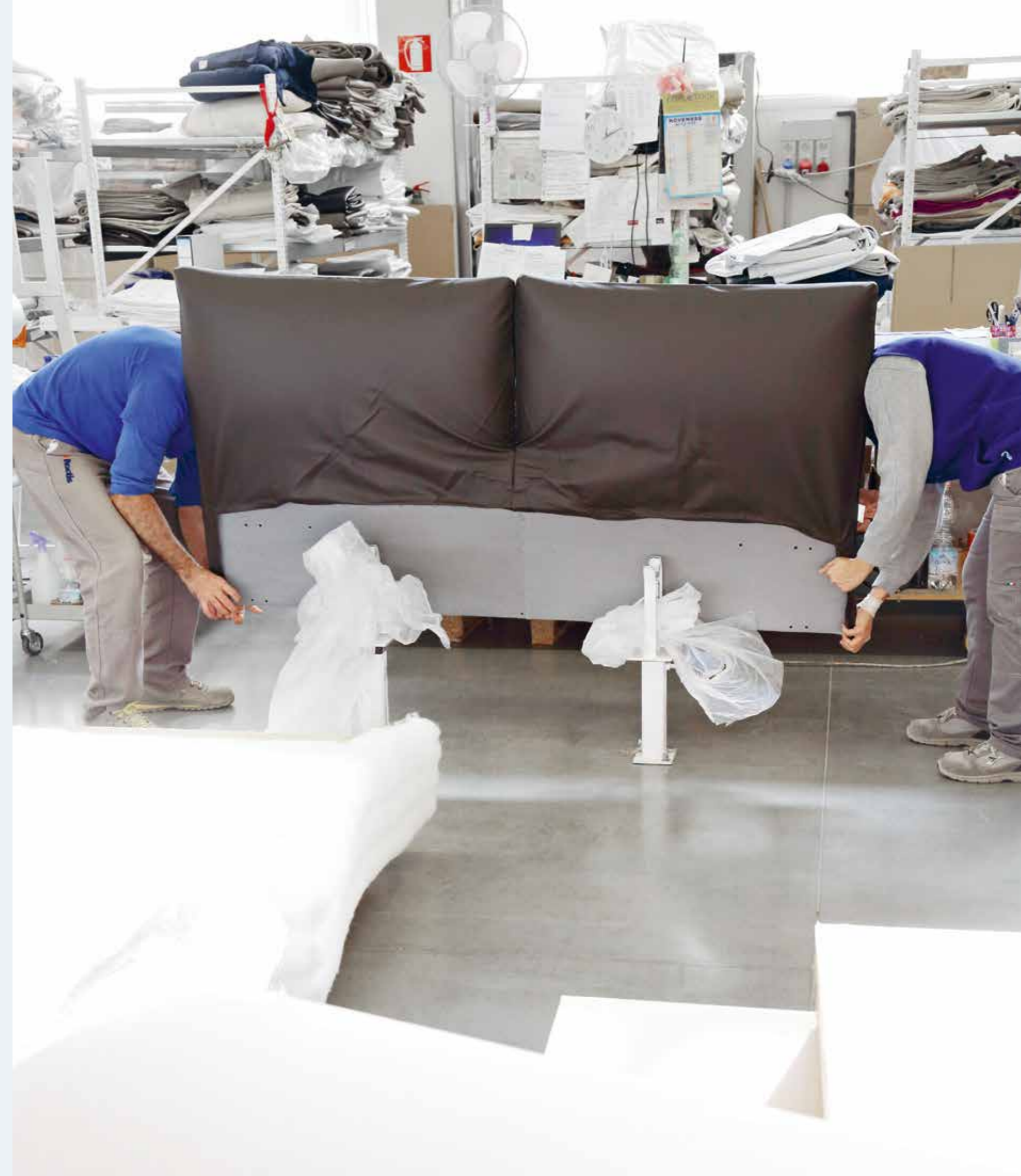
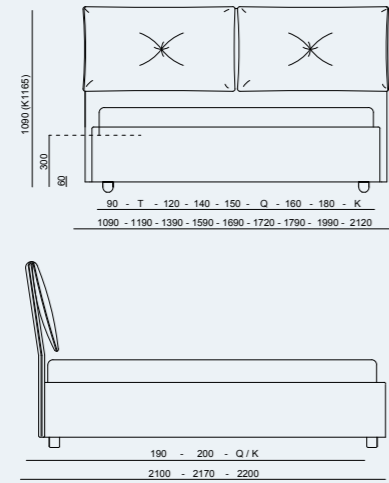
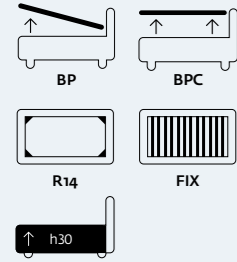

I disegni tecnici fanno riferimento al letto fornito con piedi standard. Al variare dei piedi variano anche l'altezza complessiva del letto e il piano d'appoggio del materasso. The production drawings are referred to the bed with standard feet. Any foot change will also imply a change of the height and of the mattress base.

Vera Advance

design Noctis

Vera Advance Voulant
Vera Advance Air
Vera Advance X
Vera Advance

Riscoprire la bellezza
nella semplicità.

—
Rediscover beauty
in simplicity.
—



Vera Advance Voulant

Vera advance voulant è la new entry della famiglia Vera. Il grande cuscini della testata lo rende unico nel suo genere. Morbido ma anche funzionale grazie alla sua completa sfoderabilità. Nelle versioni singole è realizzato con cuscino unico. Disponibile con diverse tipologie di piede e in tutti i tessuti del campionario. Divertiti a configurare il tuo Vera su misura.

Vera advance voulant is the new entry of the Vera family. The large headboard cushions make it unique. Soft but also functional thanks to its complete removable cover. In single versions it is made with a single cushion. Available with different types of foot and in all the fabrics of the samples. Have fun configuring your customized Vera.



Vera Advance Voulant 90
Penelope o8, cat. C
piede P2 natural
P2 natural foot
H 110

Volo

attraverso le stanze
e fra gli alberi, disegno contorni
alle forme perfette

Flight

through rooms and
among trees, I draw contours
to perfect shapes



Vera Advance Voulant 160
Velluto 14, cat. C
piede P2 natural
P2 natural foot
H 110



Look personalizzabile grazie alla sua testiera dai cuscini trasformabili.

—
Customizable look thanks to its headboard with convertible pillows.
—



Vera Advance Air

Nella versione Air il letto Vera si presenta con i due cuscini rifiniti dalla perimetrale cucitura pizzicata che crea un bordo volant caratterizzandone lo stile. Nella versione da una piazza e nella versione da 120, realizzato con un unico cuscino.

In Air version Vera AD Air is presented with two soft cushions finished with a perimetric plucked sewing making a volant edge which gives style to the model. In single version and in the 120 version, it is realized with a unique cushion.



Vera Advance Air 160
Brando 23, cat. B
piede P2 wengè
P2 wengè foot
H 110



Vera Advance Air 160
Mover violette, cat. C
piede P2 wengè
P2 wengè foot
H 110

Vera Advance X



accogliente

tutto il comfort
che desideri



attractive

all the comfort
you wish

Vera Advance X 160
Smile g104, cat. C
piede pp obliquo bianco
pp white oblique foot
H 110





Vera Advance X

Vera X è un prodotto storico della collezione Noctis che ora è aggiornato nelle linee grazie alla testata più alta e leggermente inclinata. In versione Singolo e da una piazza e mezza il cuscino diventa unico ed è sempre realizzato in morbida ovatta trapuntata.

Vera X is an historic product of Noctis Collection revised in its lines thanks to the higher headboard slightly inclined. In single and 120 versions a unique soft quilted cushion is provided.



Vera Advance X 120
Panama 570, cat. C
piede alluminio obliquo
aluminum oblique foot
H 110



Vera Advance

Versione base della famiglia Vera. Il cuscino a "saponetta" con la leggera piega cucita ai lati dona al letto originalità e al tempo stesso non stravolge la semplicità di un'estetica che sa adattarsi ad ogni situazione. La struttura come per tutti i Vera è realizzata in schiumati e materiali di alta qualità.

Standard version of Vera bed model. The "soap bar" shape cushion with a light bend at sides, gives originality to the bed and at the same time keeps the simplicity of its aesthetic idea, easily adaptable to any situation. As per anyone of Vera models, the structure is realized in polyurethane foam of high quality.

Vera Advance 160
Smile 9525, cat. C
piede pp nero
pp black foot
H 60



soffice
delicatezza e personalità



soft
delicacy and personality

Vera Advance 160
Smile 9525, cat. C
piede pp nero
pp black foot
H 60

Vera advance voulant

↳ Disponibile in tutti i tessuti del nostro campionario ↳ Nelle Larghezze King, 180, 160, Queen, 150, 140, 120, Twin, 90

↳ Available in all the fabrics of our catalogue ↳ Bed sizes available: King, 180, 160, Queen, 150, 140, 120, Twin, 90

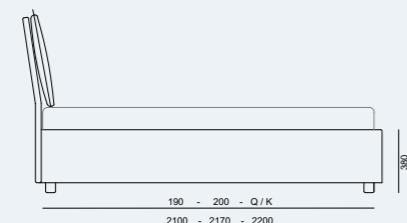
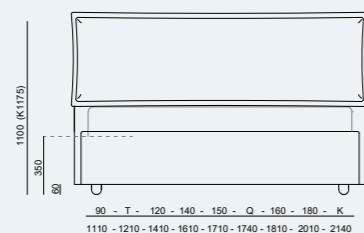
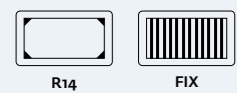
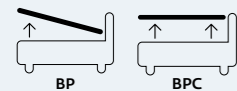

Vera Advance

↳ Disponibile in tutti i tessuti del nostro campionario ↳ Nelle Larghezze King, 180, 160, Queen, 150, 140, 120, Twin, 90

↳ Available in all the fabrics of our catalogue ↳ Bed sizes available: King, 180, 160, Queen, 150, 140, 120, Twin, 90

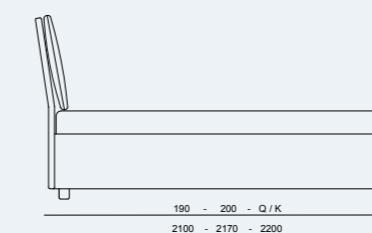
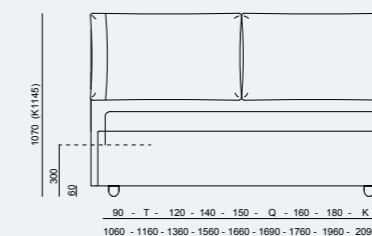
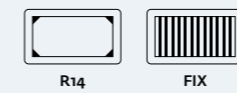
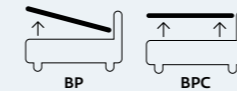

Vera Advance Air

↳ Disponibile in tutti i tessuti del nostro campionario ↳ Nelle Larghezze King, 180, 160, Queen, 150, 140, 120, Twin, 90

↳ Available in all the fabrics of our catalogue ↳ Bed sizes available: King, 180, 160, Queen, 150, 140, 120, Twin, 90

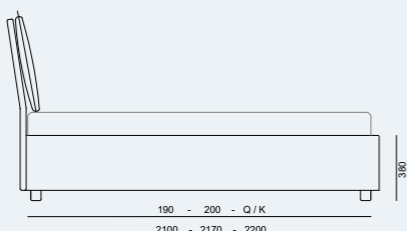
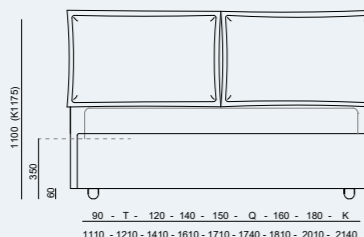
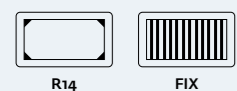
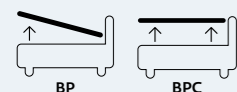

Vera Advance X

↳ Disponibile in tutti i tessuti del nostro campionario ↳ Nelle Larghezze King, 180, 160, Queen, 150, 140, 120, Twin, 90

↳ Available in all the fabrics of our catalogue ↳ Bed sizes available: King, 180, 160, Queen, 150, 140, 120, Twin, 90

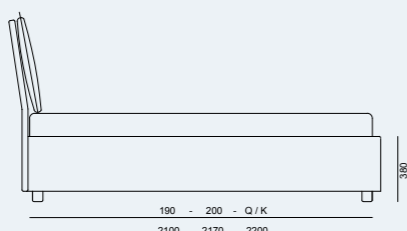
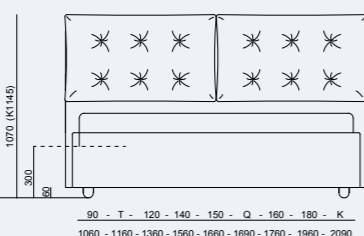
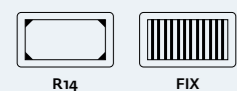
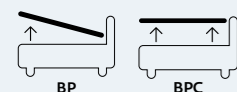

I disegni tecnici fanno riferimento al letto fornito con piedi standard. Al variare dei piedi variano anche l'altezza complessiva del letto e il piano d'appoggio del materasso. The production drawings are referred to the bed with standard feet. Any foot change will also imply a change of the height and of the mattress base.

Manuel

design Noctis

Semplicità e modernità
si offrono ad ogni ambiente,
per ogni esigenza.

—
Simplicity and modernity
offer themselves to any
environment, for any need.
—



Manuel
Silvia 23, cat. C
piede pp obliquo bianco
pp oblique white foot
H 110



accattivante

dal profilo moderno
e intramontabile

attractive

with its modern profile
and timeless

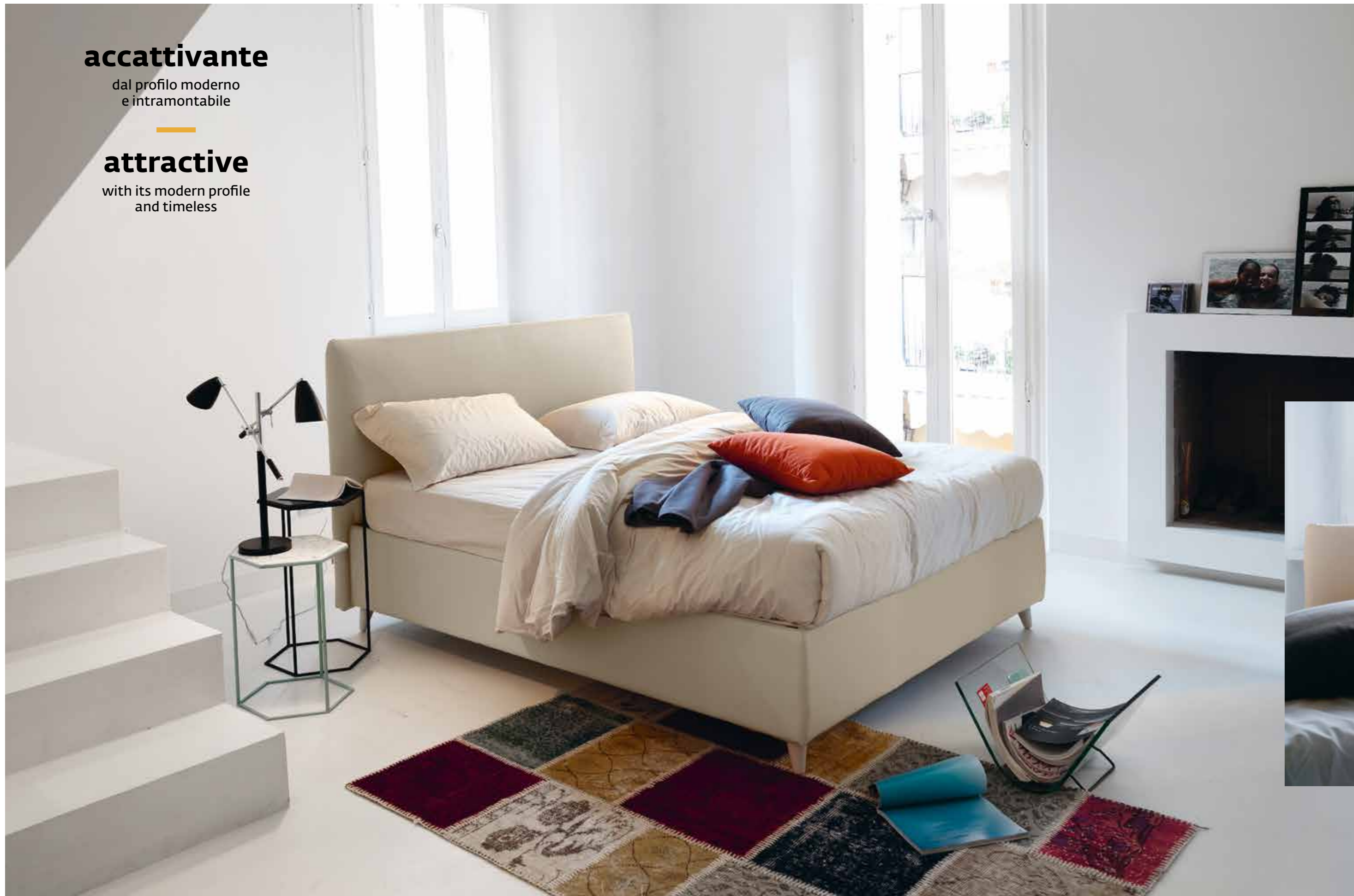

Manuel
Silvia 23, cat. C
piede pp obliquo bianco
pp oblique white foot
H 110

Manuel

Grande Capienza del contenitore, semplicità delle linee, minimo ingombro. Manuel è il letto che sa adattarsi ad ogni occasione. Disponibile in tutti i tessuti del nostro campionario è realizzato in soffici schiumati che lo rendono morbido al tatto in ogni suo punto.

Large storage capacity, simplicity of lines, and minimum overall dimensions. Manuel is the bed which can be adapted to each situation. Available in all fabrics of our samples collection. It is realized in soft polyurethane foam which makes Manuel smooth to the touch in point any.



Manuel
Smile 9848, cat. C
piede pp nero
pp black foot
H 60



Manuel
Silvia 23, cat. C
piede pp obliquo bianco
pp oblique white foot
H 110

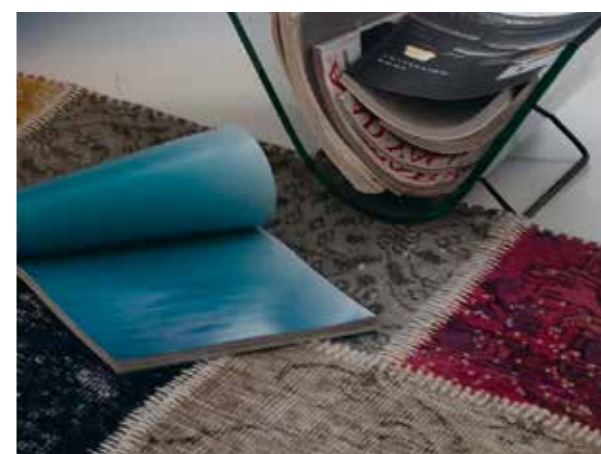

Manuel

↳ Disponibile in tutti i tessuti del nostro campionario ↳ Nelle Larghezze King, 180, 160, Queen, 150, 140, 120, Twin, 90

↳ Available in all the fabrics of our catalogue ↳ Bed sizes available: King, 180, 160, Queen, 150, 140, 120, Twin, 90

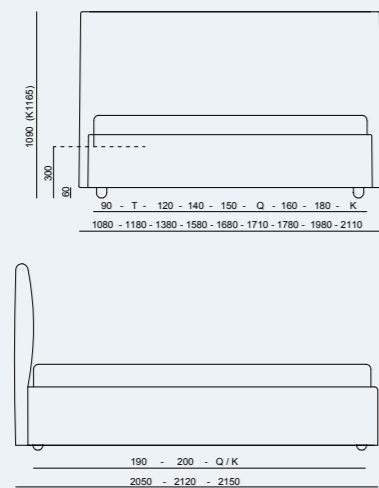
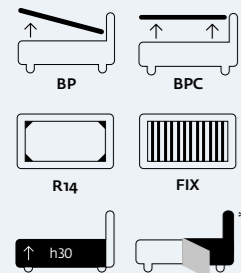

* Sfoderabile previo smontaggio della testiera
Removable after removing the headboard

I disegni tecnici fanno riferimento al letto fornito con piedi standard.
Al variare dei piedi variano anche l'altezza complessiva del letto e il piano d'appoggio del materasso. The production drawings are referred to the bed with standard feet. Any foot change will also imply a change of the height and of the mattress base.



Smart

design Noctis

Cuore gentile quello del nuovo letto Smart, la sua morbida trapuntina sfoderabile e lavabile separatamente.

—
kind heart that one of Smart bed, its soft quilted cushion, separately removable and washable.



Smart 160
Panama 450, cat. C
piede P2 bianco
P2 white foot
H60





comodità
senza perdere
lo stile



soft
without losing
style

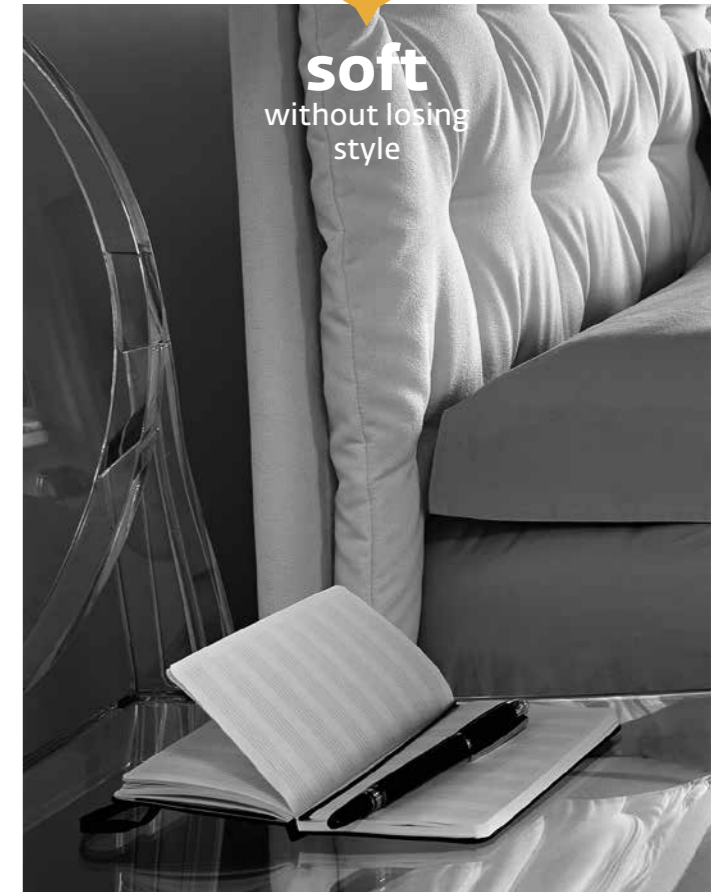

Smart 160
Panama 450, cat. C
piede P2 bianco
P2 white foot
H60



Smart 90
Panama 380, cat. C
piede P2 natural
P2 natural foot
H60

Smart

La testata del letto Smart è composta da un cuscino rimovibile trapuntato a crocette. Al momento dell'ordine possono essere indicati due codici e due tessuti differenti per il cuscino e per la struttura al fine di personalizzare al massimo il tuo letto.

Smart's headboard is composed by a crossed quilted removable cushion. Two different codes for different fabrics may be indicated at the moment of the order confirmation to personalize at best your own bed.



Smart 160
Panama 512, cat. C
piede P2 bianco
P2 white foot
H60



Smart 90
Panama 570, cat. C
piede P2 wengè
P2 wengè foot
H60

Smart

↳ Disponibile in tutti i tessuti del nostro campionario
 ↳ Trapunta e struttura ordinabili separatamente per abbinamento bicolore
 ↳ Nelle larghezze 180, 160°, 150°, 140°, 120°, 90°
 ↳ In tinta unita o con rivestimento differente per struttura e trapunta testata

↳ Available in all the fabrics of our catalogue
 ↳ Quilt and structure ordered separately to match two-color
 ↳ Bed sizes available: 180, 160°, 150°, 140°, 120°, 90° cm widths
 ↳ Matching tint or different covering for the structure and the quilted headboard

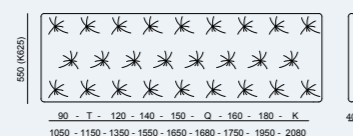
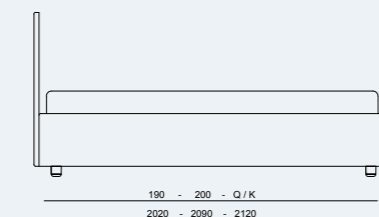
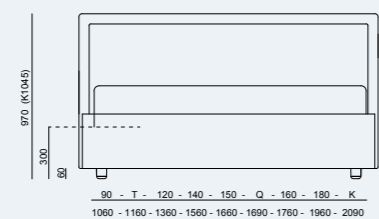
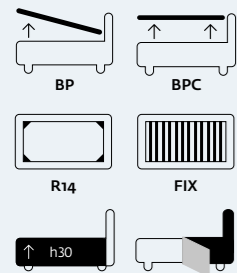

I disegni tecnici fanno riferimento al letto fornito con piedi standard.
 Al variare dei piedi variano anche l'altezza complessiva del letto e il piano d'appoggio del materasso. The production drawings are referred to the bed with standard feet. Any foot change will also imply a change of the height and of the mattress base.



Me

design Noctis

Me L

Me, elegante, pragmatico
e pratico anche
in versione contenitore.

Me, elegant, pragmatic
and practical. also with
the storage container base.



ME L 160
Panama 119, Cat. C
abbinamento bicolore var. 6
combination bicolor var. 6
piede campana
bell foot



Me & Me L

tutta l'eleganza della
semplicità

—
all the elegance of
simplicity

Me

Il morbido rivestimento facilmente rimovibile con il bordino perimetrale in contrasto di colore o in tinta unita caratterizza il letto **Me**. Disponibile in tinta unita o in abbinamento bicolore.

The soft cover, easily removable with perimetral edge in contrast with main color or in plain one, characterizes **Me** bed model. Available in plain color or bicolor.



Me 160
Panama 380, cat. C
abbinamento bicolore var. 4
combination bicolor var. 4
piede campana
foot bell

Me L

Nella versione **Me L** la testata del letto diventa più alta di 40 centimetri, raggiungendo quota 138 cm. Questi volumi abbinati alle caratteristiche tecniche di realizzazione del letto Me creano un prodotto raffinato e un po' "snob".

In "**Me L**" version the headboard becomes higher of 40 cm, reaching cm 138 height. These volumes combined with technical characteristics of ME model realization create a refined and a little "snob" product.



Me L 160
Panama 119, cat. C
abbinamento bicolore var. 6
combination bicolor var. 6
piede campana
foot bell

Abbinamenti bicolore Bicolor combination

Me & Me L sono disponibili in tinta unita o in sei abbinamenti bicolore realizzati in tessuto Panama con bordino perimetrale a contrasto.

Me & Me L are available in plain color or if in bicolor combination have to be realized in Panama fabric with perimetral edge in contrast.



Var.1 Panama 320
bordo blu abbinato
biancheria 0000 bordo blu
board paired blue
0000 bedlinen blue border



Var.2 Panama 450
bordo bianco abbinato
biancheria 0000 bordo ecru
board paired white
0000 bedlinen ecru border



Var.3 Panama 512
bordo azzurro abbinato
biancheria 2571 bordo grigio
board paired blue
2571 bedlinen grey board



Var.4 Panama 380
bordo bianco abbinato
biancheria 0000 bordo blu
board paired white
0000 bedlinen blue border



Var.5 Panama 512
bordo bianco abbinato
biancheria 0000 bordo grigio
board paired white
0000 bedlinen grey board



Var.6 Panama 119
bordo blu abbinato
biancheria 2800 bordo tortora
board paired blue
2800 bedlinen taupe board

Me

↳ Disponibile in tutti i tessuti del nostro campionario ↳ Nelle larghezze King, 180, 160, Queen, 150, 140, 120, Twin, 90
↳ In tinta unita o nelle 6 varianti di abbinamento bicolore

↳ Available in all the fabrics of our catalogue ↳ Bed sizes available: King, 180, 160, Queen, 150, 140, 120, Twin, 90 cm widths ↳ Matching tint or in 6 types of twin colour matching

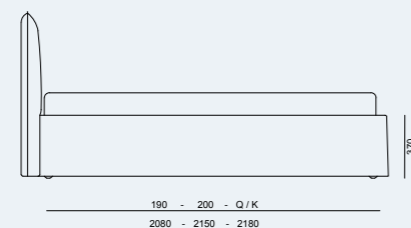
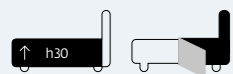
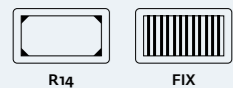
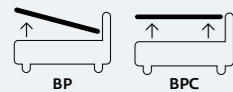

Me L

↳ Disponibile in tutti i tessuti del nostro campionario ↳ Nelle larghezze King, 180, 160, Queen, 150, 140 ↳ In tinta unita o nelle 6 varianti di abbinamento bicolore

↳ Available in all the fabrics of our catalogue ↳ Bed sizes available: King, 180, 160, Queen, 150, 140 cm widths ↳ Matching tint or in 6 types of twin colour matching

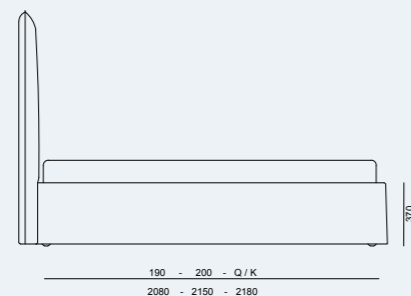
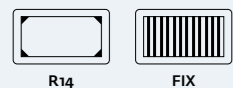
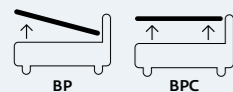

I disegni tecnici fanno riferimento al letto fornito con piedi standard.
Al variare dei piedi variano anche l'altezza complessiva del letto e il piano d'appoggio del materasso. The production drawings are referred to the bed with standard feet. Any foot change will also imply a change of the height and of the mattress base.

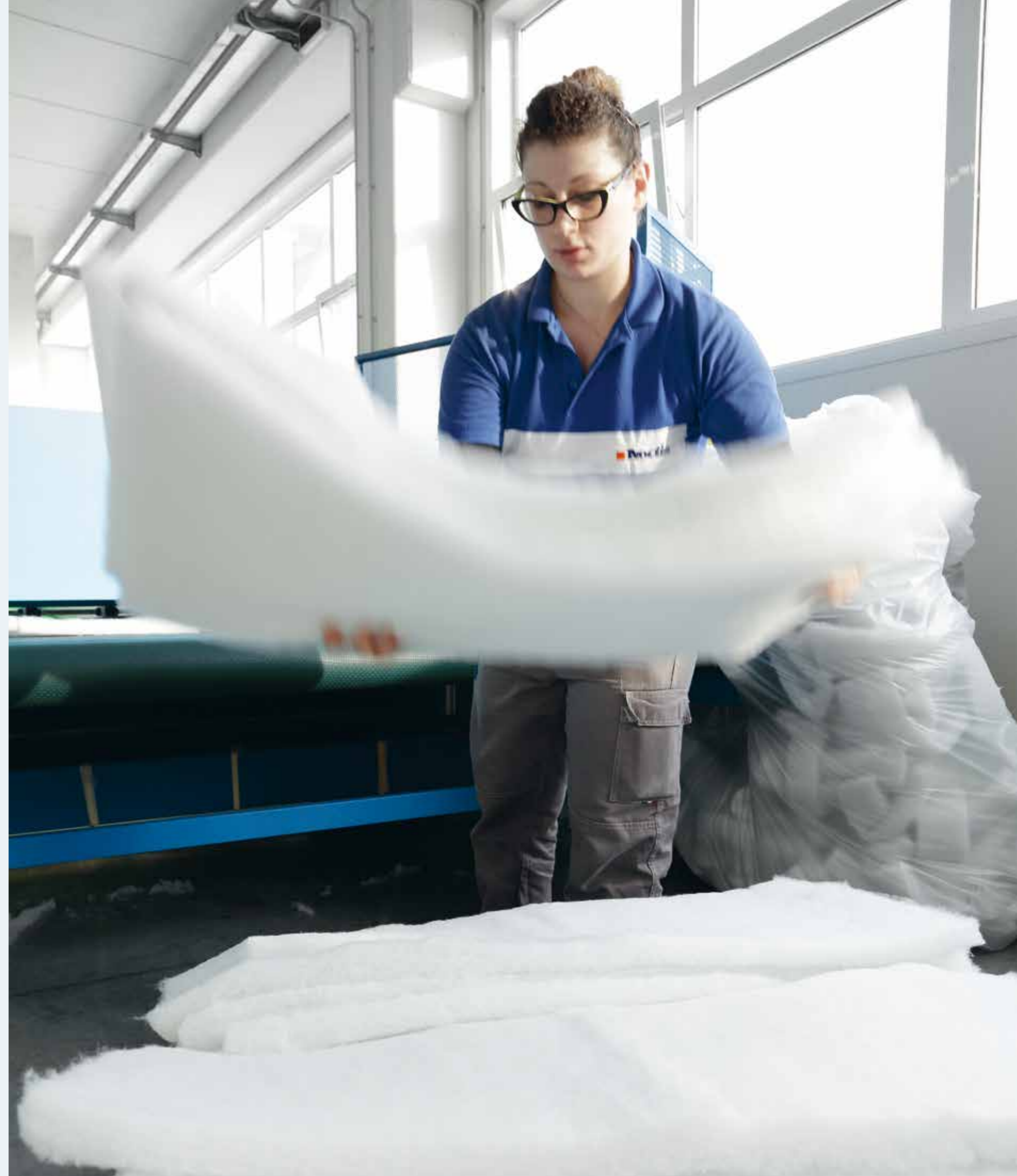

Guru

Guru H10

Guru. semplicità,
eleganza, artigianalità.

Guru. Simplicity,
elegance, craftsmanship.

design Noctis



Guru 160 H10
Mover Rye, cat. C
piede slitta
slide foot
H 150

Guru H10

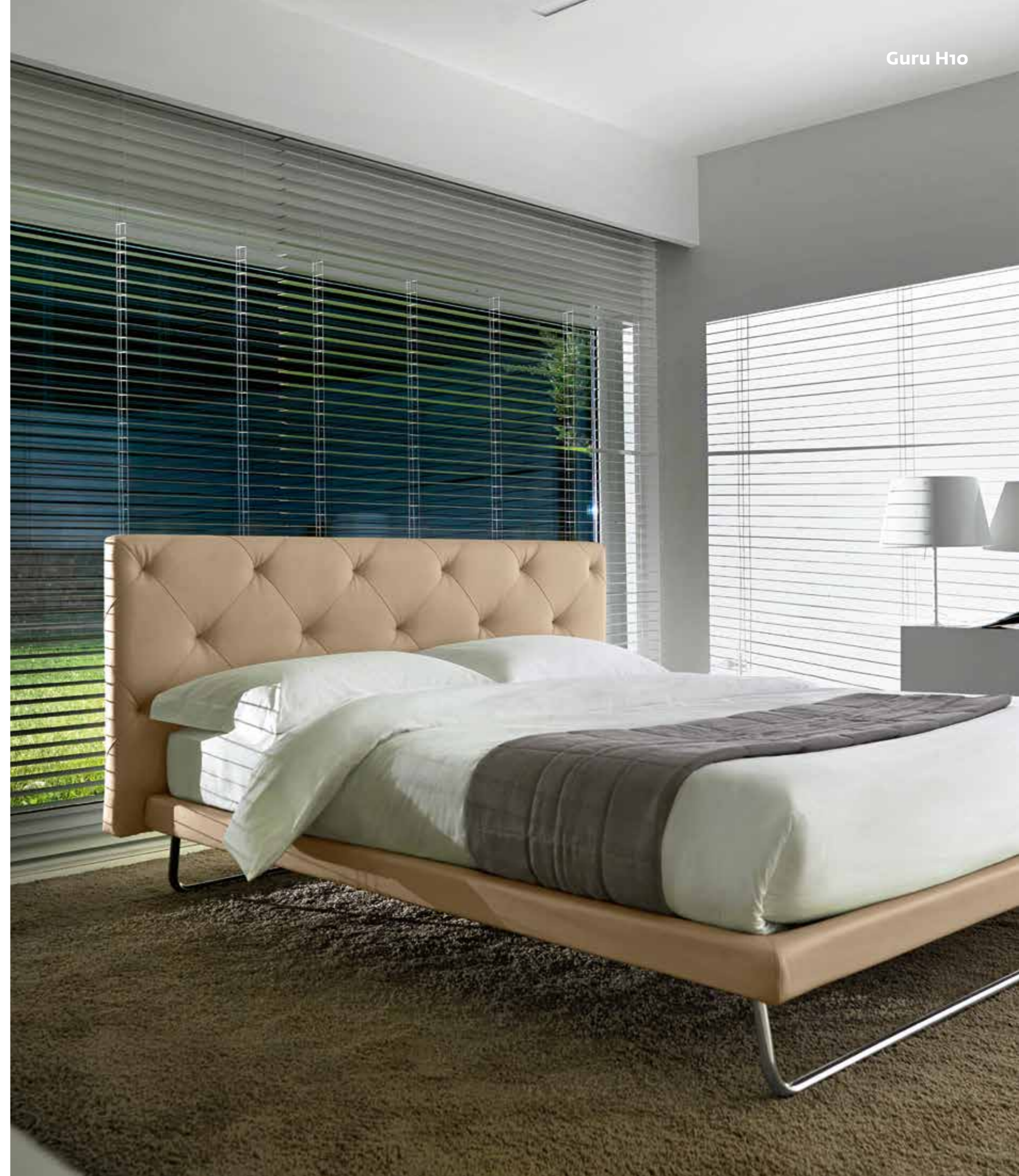



Guru 160 H10
Mover Rye, cat. C
piede slitta
slide foot
H 150



Guru 160
Mover Opticwhite, cat. C
piede alluminio obliquo
oblique aluminum foot
H 110

Guru

La testata del letto Guru è realizzata dai maestri artigiani della nostra azienda. l'effetto morbidezza che lo contraddistingue è dovuto ad un sapiente utilizzo di schiumati di alta qualità. Le dimensioni contenute lo rendono adatto anche agli spazi più piccoli.

Guru headboard is realized by master craftsmen in our company. The smoothy effect which characterizes this model, is obtained thanks to a masterly use of high quality polyurethane foam. The compact design makes it suitable even for small spaces .



elegante
versione h10 con piede
slitta cromo



elegant
h10 version with foot
chrome slide

Guru 160 H10
Mover Rye, cat. C
piede slitta
slide foot
H 150



Semplicità //eleganza

Volumi lavorati
artigianalmente.



Simplicity //elegance

Volumes worked
by craftsmen.

Guru 160
Mover Opticwhite, cat. C
piede alluminio obliquo
oblique aluminum foot
H 110

Guru

↳ Non sfoderabile ↳ Disponibile solo in pelle, similpelle e nei tessuti antimacchia
 ↳ Nelle larghezze King, 180, 160, Queen, 150, 140, 120, Twin, 90

↳ Non removable cover ↳ Only available in leather, e-leather and dirt-proof fabrics
 ↳ Bed sizes available King, 180, 160, Queen, 150, 140, 120, Twin, 90, cm widths

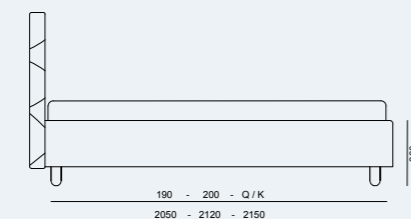
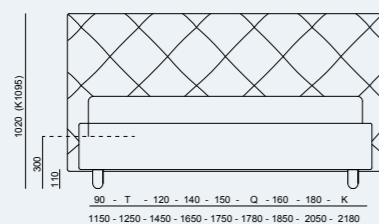
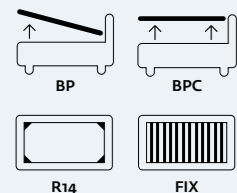

Guru H10

↳ Non sfoderabile ↳ Disponibile solo in pelle, similpelle e nei tessuti antimacchia
 ↳ Nelle larghezze King, 180, 160, Queen, 150, 140, 120, Twin, 90

↳ Non removable cover ↳ Only available in leather, e-leather and dirt-proof fabrics
 ↳ Bed sizes available King, 180, 160, Queen, 150, 140, 120, Twin, 90, cm widths

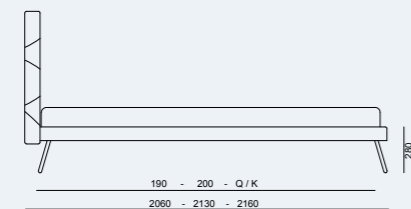
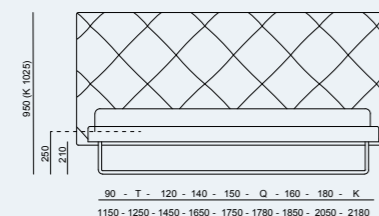

I disegni tecnici fanno riferimento al letto fornito con piedi standard. Al variare dei piedi variano anche l'altezza complessiva del letto e il piano d'appoggio del materasso. The production drawings are referred to the bed with standard feet. Any foot change will also imply a change of the height and of the mattress base.



Duck

design Noctis

Soffice Duck,
per veri sognatori.
—
Soft Duck dedicated
to real dreamers
—



Duck

Morbidoso e al tempo stesso geometrico con grande stile. **Duck** è realizzato con schiumati abbinati a soffice ovatta che riempiono i suoi volumi dal grande effetto. Completamente sfoderabile è realizzabile in tutti i tessuti del nostro campionario.

Soft and geometric at the same time with great taste. **Duck** is realized with polyurethane foam combined with soft cotton wool which fills its volumes with great effect. Completely removable it is available in all fabrics of our samples collection.



Duck 160
Brando 28, cat. B
piede square wenge
wenge square foot
H40



Duck 160
Brando 07, cat. B
piede square wenge
wenge square foot
H40

delicato

il letto per
sognare



delicate

the bed to
dream



Duck

↳ Disponibile in tutti i tessuti del nostro campionario ↳ Nelle larghezze King, 180, 160, Queen, 150, 140, 120, Twin, 90

↳ Available in all the fabrics of our catalogue ↳ Bed sizes available King, 180, 160, Queen, 150, 140, 120, Twin, 90 cm widths

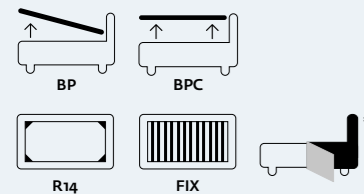

* Sfoderabile previo smontaggio della testiera
Removable after removing the headboard

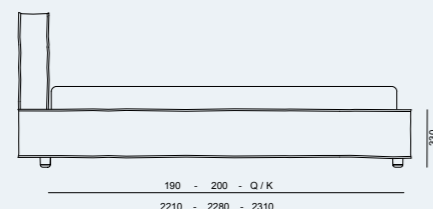
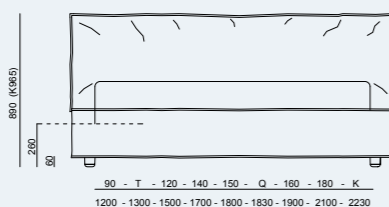

I disegni tecnici fanno riferimento al letto fornito con piedi standard.
Al variare dei piedi variano anche l'altezza complessiva del letto e il piano d'appoggio del materasso. The production drawings are referred to the bed with standard feet. Any foot change will also imply a change of the height and of the mattress base.



Dizzy

Dizzy High

design Noctis



Dizzy, vero capitonnè
realizzato uno a uno
da maestri artigiani.

Dizzy, true capitonnè
working, realized one by
one by master craftsmen.



Dizzy 160
Mover DK brown, cat. C
piede P2 wenge
P2 wenge foot
H60

**capitonné
artigianale**

maestria & eleganza



**button
upholstery**

skill & elegance

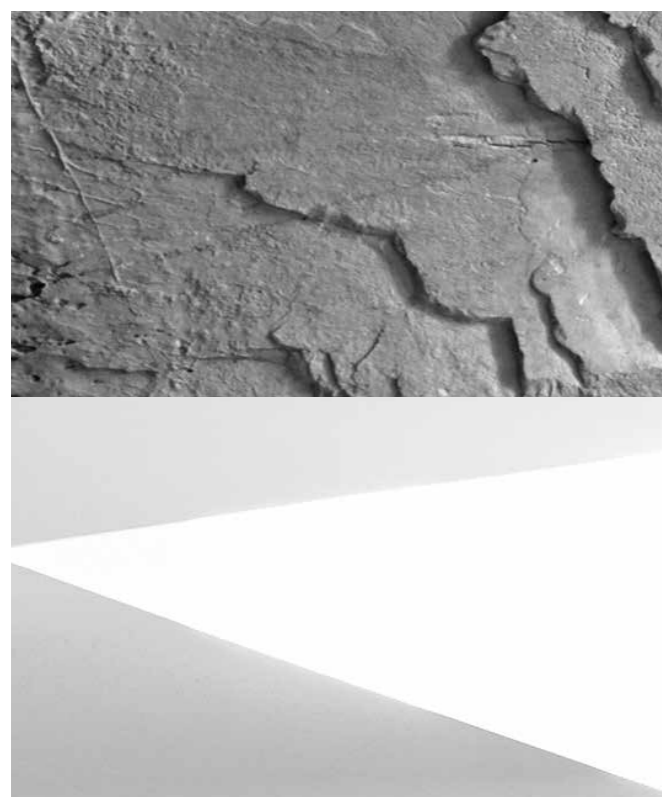

Dizzy high 160
Mover Opticwhite, cat. C
piede wave bianco
white wave foot
H11

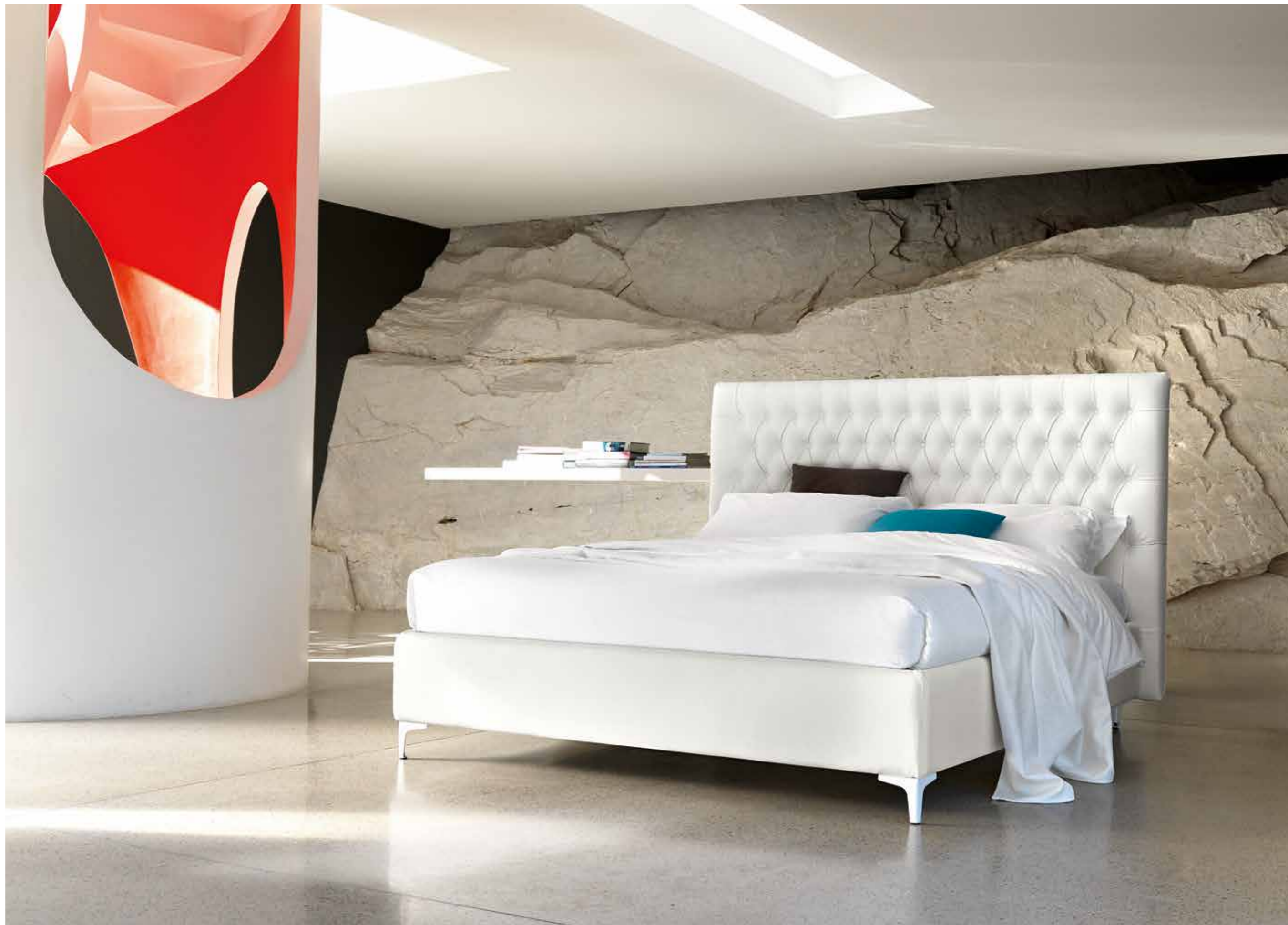

Dizzy

Classica lavorazione capitonnè per un letto che non può mancare all'interno di una collezione. Realizzabile in ecopelle o pelle.

With its Classical manual process capitonnè **Dizzy** is a bed that cannot be missed in any collection. Available in eco leather and leather .



Dizzy 160
Mover Dk brown, cat. C
piede P2 wenge
P2 wenge foot
H60



Dizzy High

Nella versione **High** la testata del letto diventa più alta di 24 centimetri, raggiungendo quota 125 cm. Questi volumi abbinati alla lavorazione capitonnè creano un letto di grande importanza.

In high version headboard becomes higher of 24 cm, reaching cm 125 height. These volumes combined with a capitonnè manufacturing create a model of great importance.

Dizzy high 160
Mover Opticwhite, cat. C
piede wave bianco
white wave foot
H111



Dizzy

↻ Non sfoderabile ↻ Disponibile solo in pelle, ecopelle e tessuti antimacchia
 ↻ Nelle larghezze King, 180, 160, Queen, 150, 140, 120, Twin, 90

↻ Non removable cover ↻ Only available in leather, e-leather and dirt-proof fabrics
 ↻ Bed sizes available King, 180, 160, Queen, 150, 140, 120, Twin, 90 cm widths

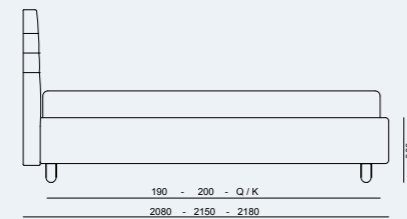
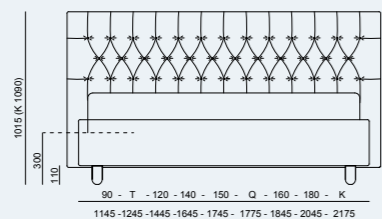
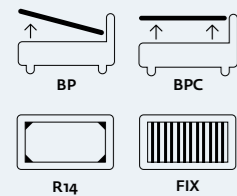

Dizzy High

↻ Non sfoderabile ↻ Disponibile solo in pelle, ecopelle e tessuti antimacchia
 ↻ Nelle larghezze King, 180, 160, Queen, 150, 140, 120, Twin, 90

↻ Non removable cover ↻ Only available in leather, e-leather and dirt-proof fabrics
 ↻ Bed sizes available King, 180, 160, Queen, 150, 140, 120, Twin, 90 cm widths

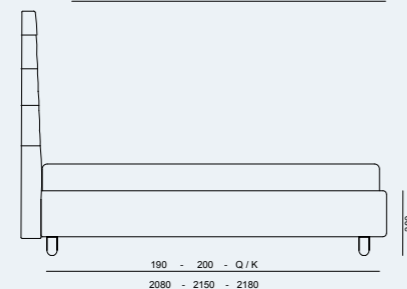
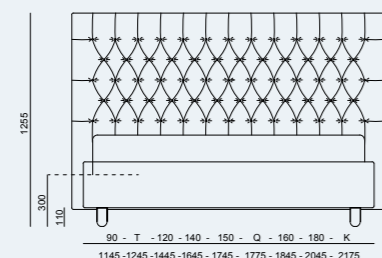
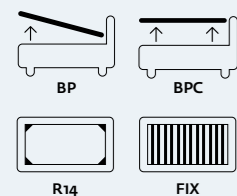

I disegni tecnici fanno riferimento al letto fornito con piedi standard. Al variare dei piedi variano anche l'altezza complessiva del letto e il piano d'appoggio del materasso. The production drawings are referred to the bed with standard feet. Any foot change will also imply a change of the height and of the mattress base.

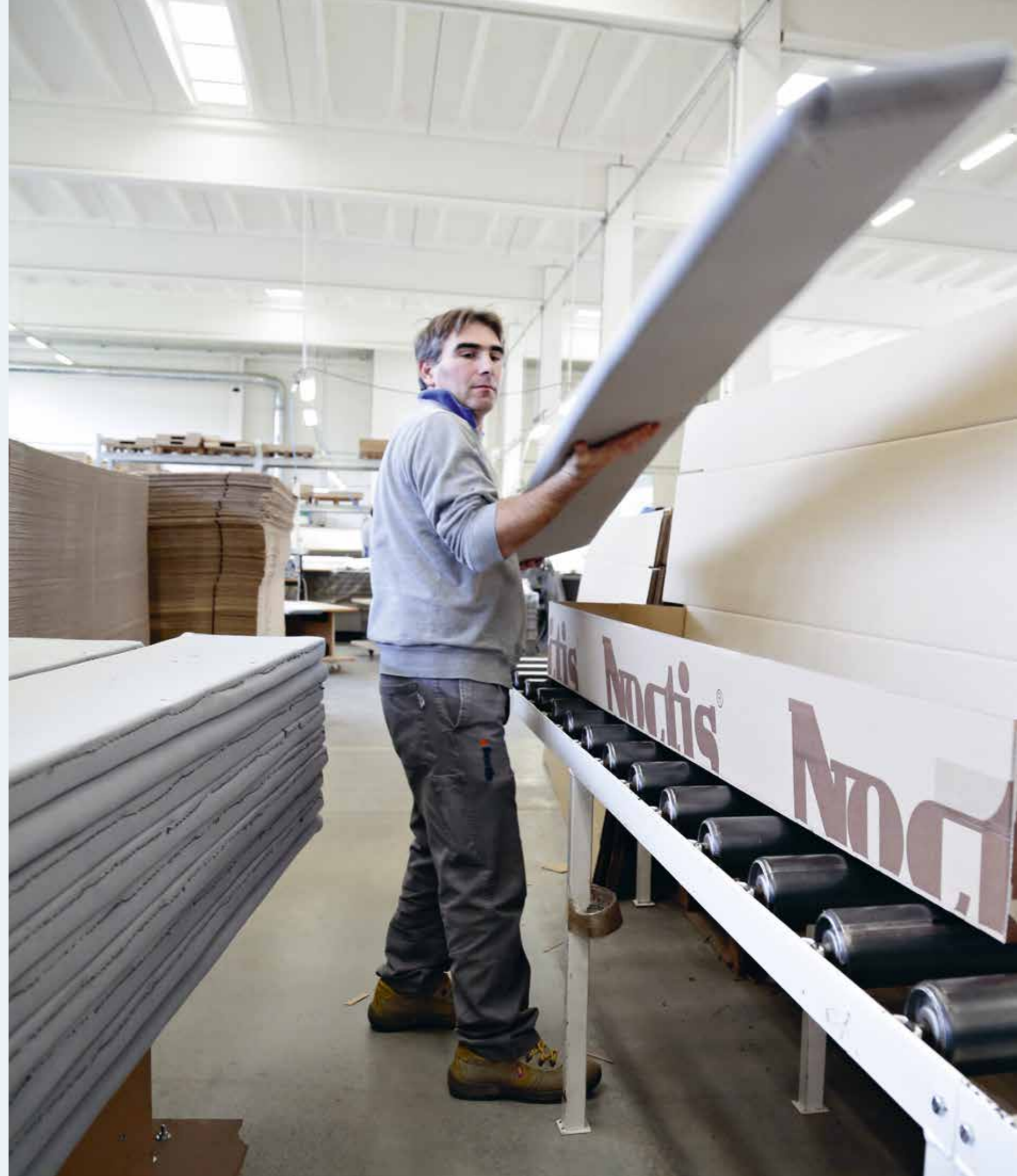

Bridge

design Noctis

Il letto tessile che diventa contemporaneo.

—
The textile bed that becomes contemporary.
—



Bridge 160
Mover Chamois, cat. C
piede P2 wengè
P2 foot wengè
H60

Semplicità

del disegno e ampie
imbotiture



Simplicity

of design and important
paddings



Bridge 160
Mover Chamois, cat. C
piede P2 wengè
P2 wengè foot
H60





Bridge 160
 Brando 20, cat. B
 piede P2 natural
P2 natural foot
 H60

Bridge

Interpreta il letto tessile in chiave contemporanea abbinando semplicità di disegno ad ampie superfici imbottite. La testata divisa in due grandi cuscini è l'elemento di questo letto che abbina una basa contenitore di grande capienza a volumi esterni tutto sommato contenuti. In versione Singolo e da una piazza e mezza il cuscino diventa unico.

It interprets the textile bed in a modern way, combining simplicity of design with large padded surfaces. The headboard, divided into two big cushions, is the component which allows a box base of high capacity with external, after all, limited volumes. In single or 120 versions cushion is single.



Bridge 160
 Brando 01, cat. B
 piede Pp nero
Pp black foot
 H60



Bridge 160
 Brando 20, cat. B
 piede P2 natural
P2 natural foot
 H60



←
→
Bridge 90
Nord wool 003, cat. A
piede Pp nero
Pp black foot
H60



Bridge da 90

il letto per il vero
riposo



Bridge 90

the bed for
real rest



Bridge

↳ Disponibile in tutti i tessuti del nostro campionario ↳ Nelle Larghezze King, 180, 160, Queen, 150, 140, 120, Twin, 90

↳ Available in all the fabrics of our catalogue ↳ Bed sizes available: King, 180, 160, Queen, 150, 140, 120, Twin, 90

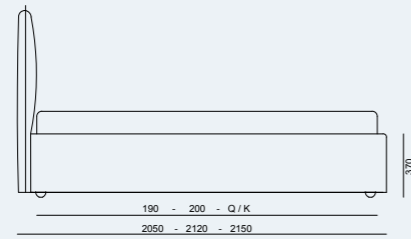
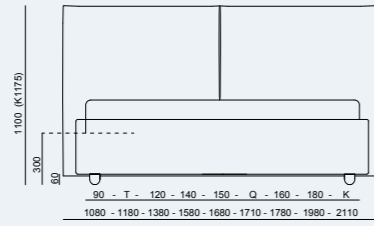
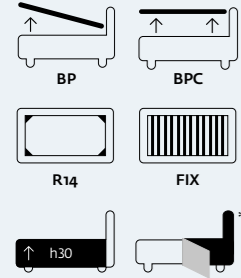

* Sfoderabile previo smontaggio della testiera
Removable after removing the headboard

I disegni tecnici fanno riferimento al letto fornito con piedi standard.
Al variare dei piedi variano anche l'altezza complessiva del letto e il piano d'appoggio del materasso. The production drawings are referred to the bed with standard feet. Any foot change will also imply a change of the height and of the mattress base.



Paris

design Noctis

Paris L

Paris, un'autentica passione classica.

Paris, an authentic classic passion



→ Paris 160
Mover white, cat. C
piede Pp obliquo bianco
Pp oblique white foot
H110



Paris



Elegante e funzionale

personalità
decisa



Elegant and functional

strong
personality



←
Paris L 160
Mover black, cat. C
piede Pp obliquo nero
Pp oblique black foot
H110



pregiato
completamente lavorato
a mano

◆ ◆ ◆
fine
completely
handmade

↑
Paris 16o
Mover white, cat. C
piede Pp obliquo bianco
Pp oblique white foot
H110

Paris

L'interpretazione Noctis di un grande classico. Realizzabile in similpelle, pelle o tessuti antimacchia. La lavorazione artigianale e il "riccio" della testata ne fanno un letto che sa dare grande importanza all'ambiente che lo circonda.

Noctis interpretation of a great classic. Available in e-leather, leather or stain-resistant fabrics. Artisan Craftsmanship and baroque curl of the headboard make Paris a model which gives great importance to the surrounding environment.



→
Paris 16o
Mover fiordaliso, cat. C
piede Pp obliquo tortora
Pp oblique dove-grey foot
H110

Paris L

Nella versione L la testata del letto diventa più alta di 20 centimetri, raggiungendo quota 108 cm. Questi volumi abbinati alla lavorazione capitonné creano un letto di grande importanza.

In L version headboard becomes 20 cm higher, reaching cm 108 height. These volumes combined with a capitonné manufacturing create a model of great importance.



→
Paris L 16o
Mover rye, cat. C
piede alluminio obliquo
foot aluminum oblique
H110

Paris

↗ Non sfoderabile ↗ Disponibile solo in pelle, ecopelle e tessuti antimacchia
↗ Nelle larghezze King, 180, 160, Queen, 150, 140

↗ Non removable cover ↗ Only available in leather, e-leather and dirt-proof fabrics
↗ Bed sizes available King, 180, 160, Queen, 150, 140 cm widths

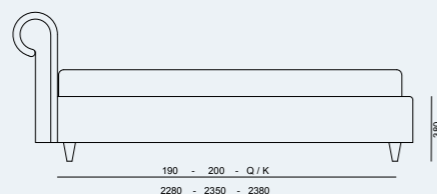
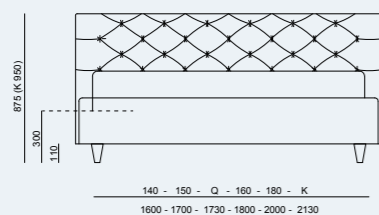
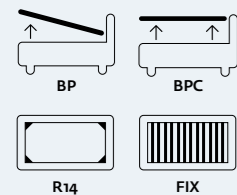

Paris L

↗ Non sfoderabile ↗ Disponibile solo in pelle, ecopelle e tessuti antimacchia
↗ Nelle larghezze larghezze King, 180, 160, Queen, 150, 140

↗ Non removable cover ↗ Only available in leather, e-leather and dirt-proof fabrics
↗ Bed sizes available King, 180, 160, Queen, 150, 140 cm widths

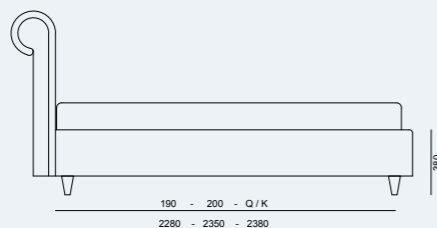
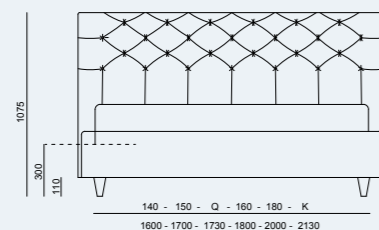
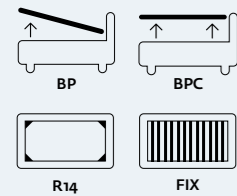

I disegni tecnici fanno riferimento al letto fornito con piedi standard.
Al variare dei piedi variano anche l'altezza complessiva del letto e il piano d'appoggio del materasso. The production drawings are referred to the bed with standard feet. Any foot change will also imply a change of the height and of the mattress base.



Dream

Dream modern
Dream modern H10
Dream capitonné

—
Dream, un dolce ritorno
alle memorie comuni.

—
Dream, a sweet return
to common memories.



Dream Modern



Dream modern 160
Nairobi 40, cat. A
piede P2 natural
P2 natural foot
H10

Dream Modern H10



Essenziale e raffinato

disponibile in tutti i tessuti e pelle



Essential and refined

Available in all materials and leather.

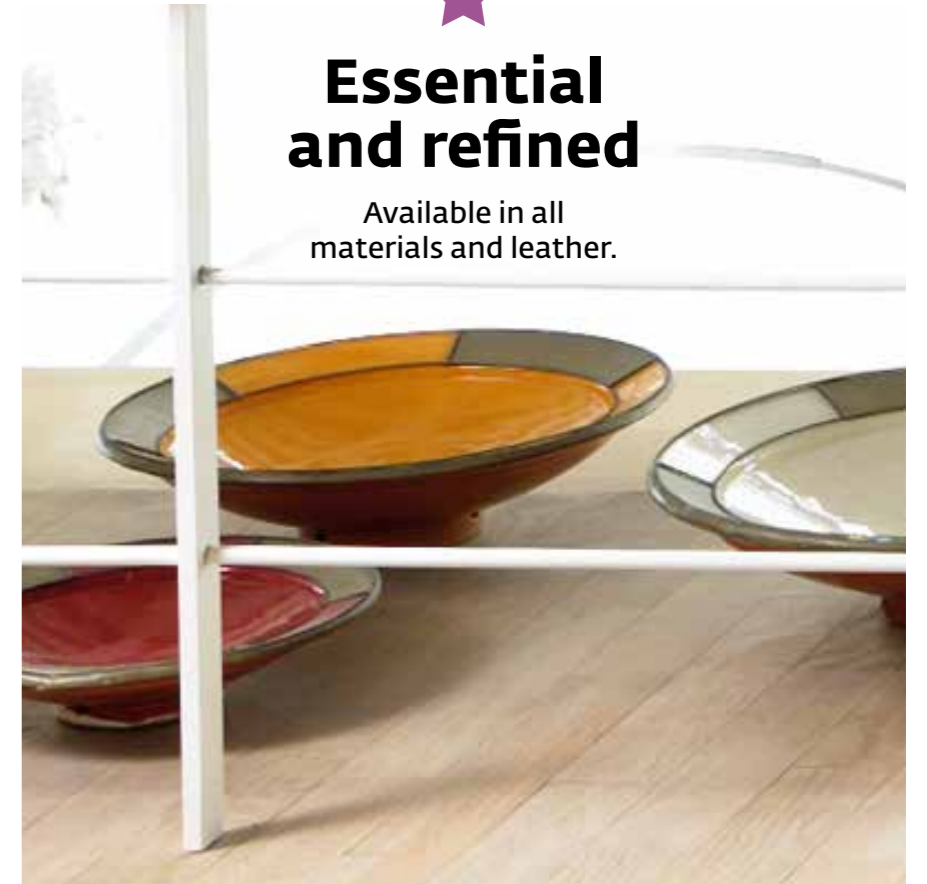

Dream modern H10 120
Brando 20, cat. B
piede P2 natural
P2 natural foot
H180



Dream capitonné

Un classico contemporaneo Dream Capitonné disponibile anche con base contenitore.

A contemporary classic Dream capitonné with button upholstery. Also available with a storage container base.



Dream capitonné 160
Mover opticwhite, cat. C
piede alluminio obliquo
aluminum oblique foot
H110

Dream modern

Un ritorno alle memorie comuni, in diverse misure e disponibile in tessuti dedicati. Stile personale, disponibile anche con base contenitore.

A return to collective memories in various sizes and available in dedicated materials. Dream endowed with personal style. Available in various sizes and dedicated materials.



Dream modern 120
Nairobi 50, cat. A
piede P2 natural
P2 natural foot
H110



Dream modern 120
Nairobi 50, cat. A
piede P2 natural
P2 natural foot
H180

Dream modern H10

Disponibile anche con giroletto H10 per chi vuole rinunciare alla presenza della base contenitore per avere un prodotto dalle linee pulite e minimal.

Available also in H10 bed frame base for those who do not wish storage version and like better minimal lines design.



Dream capitonné 90
Mover fiordaliso, cat. C
piede P2 natural
P2 natural foot
H110



Dream Capitonné 160
Mover opticwhite, cat. C
piede alluminio obliquo
aluminum oblique foot
Hno



capitonné contemporaneo

disponibile anche con
base contenitore



contemporary capitonné

also available with storage
container base.

Dream Modern

↳ Disponibile in tutti i tessuti del nostro campionario ↳ Nelle Larghezze King, 180, 160, Queen, 150, 140, 120, Twin, 90

↳ Available in all the fabrics of our catalogue ↳ Bed sizes available: King, 180, 160, Queen, 150, 140, 120, Twin, 90

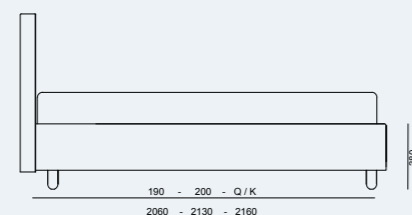
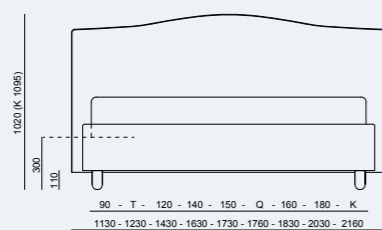
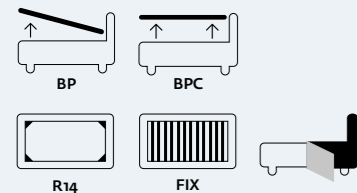

Dream Modern H10

↳ Disponibile in tutti i tessuti del nostro campionario ↳ Nelle Larghezze King, 180, 160, Queen, 150, 140, 120, Twin, 90

↳ Available in all the fabrics of our catalogue ↳ Bed sizes available: King, 180, 160, Queen, 150, 140, 120, Twin, 90

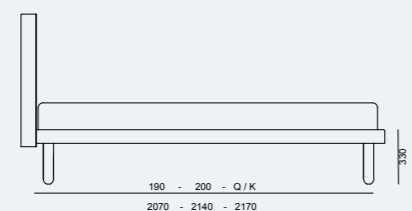
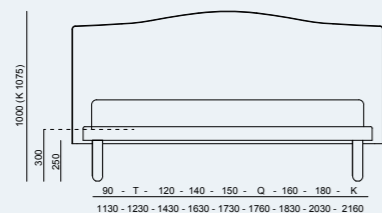

Dream Capitonnè

↳ Non sfoderabile ↳ Disponibile solo in pelle ecopelle e tessuti antimacchia ↳ Nelle Larghezze King, 180, 160, Queen, 150, 140, 120, Twin, 90

↳ Non removable cover ↳ Available only in leather, e-leather and dirt-proof fabric ↳ Bed sizes available: King, 180, 160, Queen, 150, 140, 120, Twin, 90

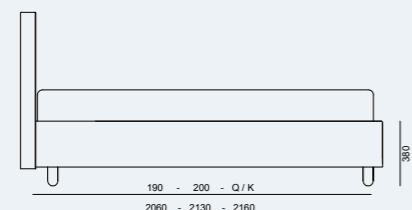
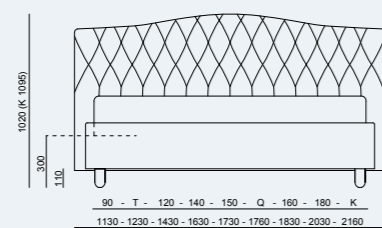
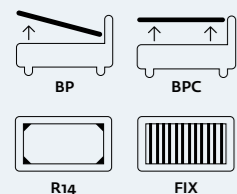

I disegni tecnici fanno riferimento al letto fornito con piedi standard. Al variare dei piedi variano anche l'altezza complessiva del letto e il piano d'appoggio del materasso. The production drawings are referred to the bed with standard feet. Any foot change will also imply a change of the height and of the mattress base.



Jazz

Jazz H10

design Noctis

Il minimal che incanta
le tue notti.

The minimal that
enchants your nights.



Jazz
Panama 117, cat. C
piede P2 natural
P2 natural foot
H10

passione jazz

disponibile anche con
base contenitore.

#

jazz passion

available with a storage
container base.

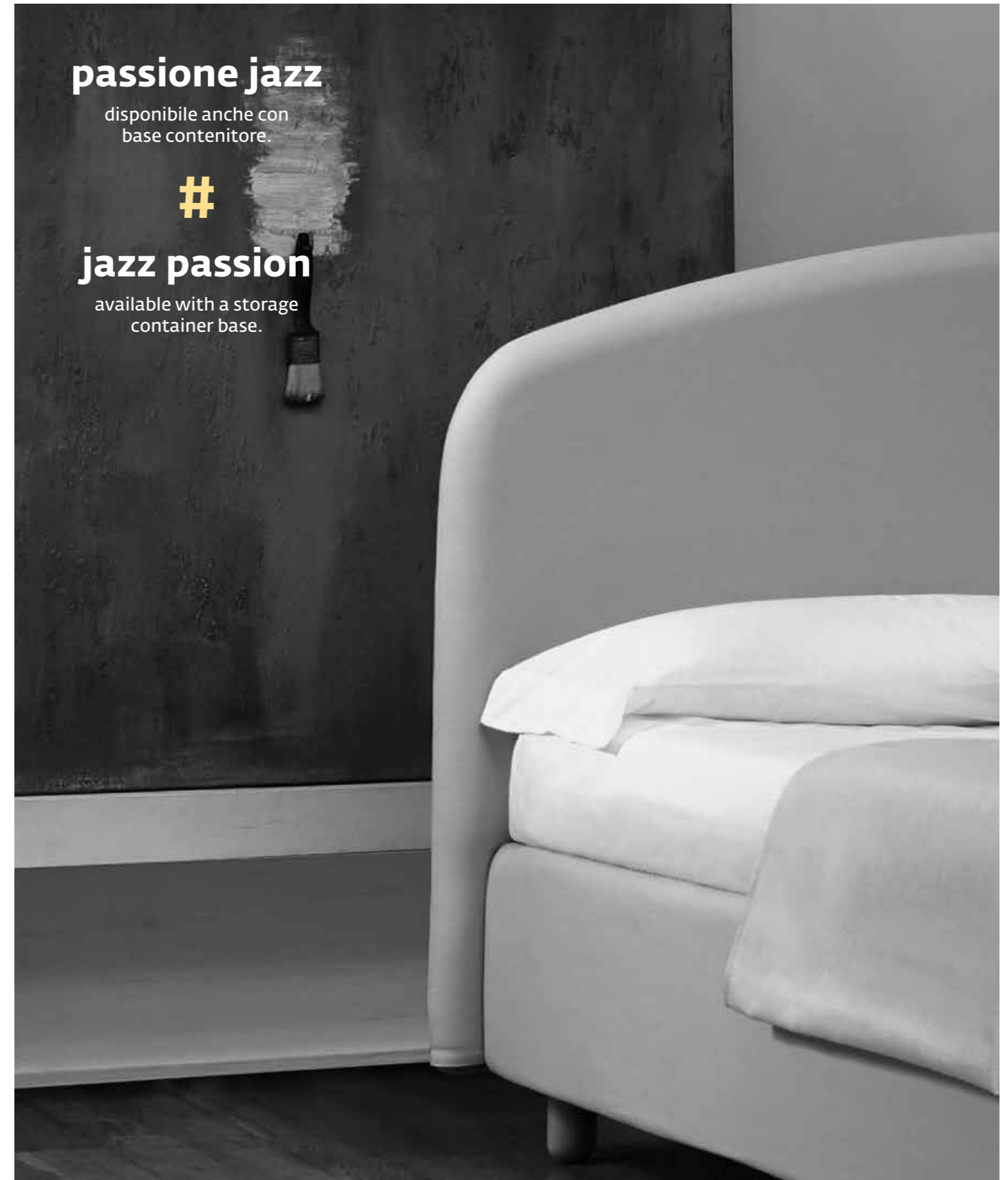



Rassicurante e pratico

disponibile in tutti
i tessuti e pelle



reassuring and practical

Available in all
materials and leather.



Jazz
Panama 117, cat. C
piede P2 natural
P2 natural foot
H110



Jazz

Il letto Jazz disponibile in diverse misure pratico nella versione con contenitore.

The JazzØ12 bed is available in various practical sizes and is also available with a storage container base.



Jazz Ø12 H10

Disponibile anche con giroletto **H10** per chi vuole rinunciare alla presenza della base contenitore per avere un prodotto dalle linee pulite e minimal. Possibile la scelta dei piedi in diversa altezza.

Available also in **H10** bed frame base for those who do not wish storage version and like better minimal lines design. Possible choice of different height feet.



←
Jazz
Panama 570, cat. C
piede P2 natural
P2 natural foot
H10

↑
Jazz H10
Panama 117, cat. C
piede P2 natural
P2 natural foot
H150

Jazz

↳ Disponibile in tutti i tessuti del nostro campionario ↳ Nelle Larghezze King, 180, 160, Queen, 150, 140, 120, Twin, 90

↳ Available in all the fabrics of our catalogue ↳ Bed sizes available: King, 180, 160, Queen, 150, 140, 120, Twin, 90

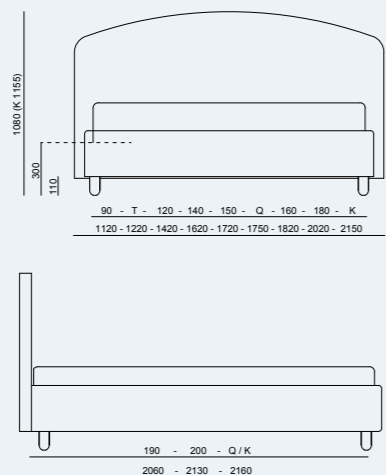
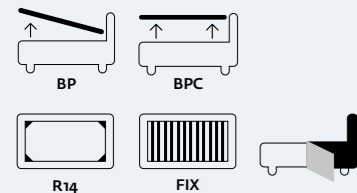

Jazz H10

↳ Disponibile in tutti i tessuti del nostro campionario ↳ Nelle Larghezze King, 180, 160, Queen, 150, 140, 120, Twin, 90

↳ Available in all the fabrics of our catalogue ↳ Bed sizes available: King, 180, 160, Queen, 150, 140, 120, Twin, 90

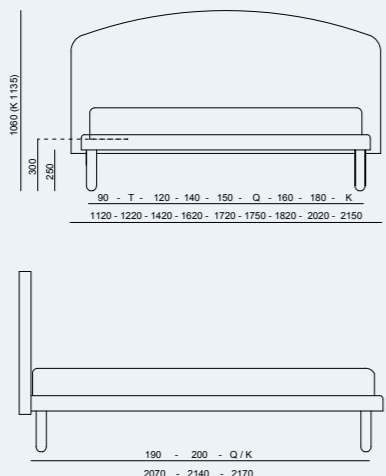

I disegni tecnici fanno riferimento al letto fornito con piedi standard. Al variare dei piedi variano anche l'altezza complessiva del letto e il piano d'appoggio del materasso. The production drawings are referred to the bed with standard feet. Any foot change will also imply a change of the height and of the mattress base.



Sommier

Sommier H10

design Noctis



Con semplicità Sommier
si addatta a ciò che vuoi.
—
With semplicity Sommier is
suitable to what you want.
—



Libertà
fantasia
condivisione



freedom
imagination
sharing



Sommier 90
Silvia 30, cat. C
piede P2 natural
P2 natural foot
H60



Minimal e funzionale

disponibile in tutti i tessuti e pelle



Minimal and functional

Available in all materials and leather.

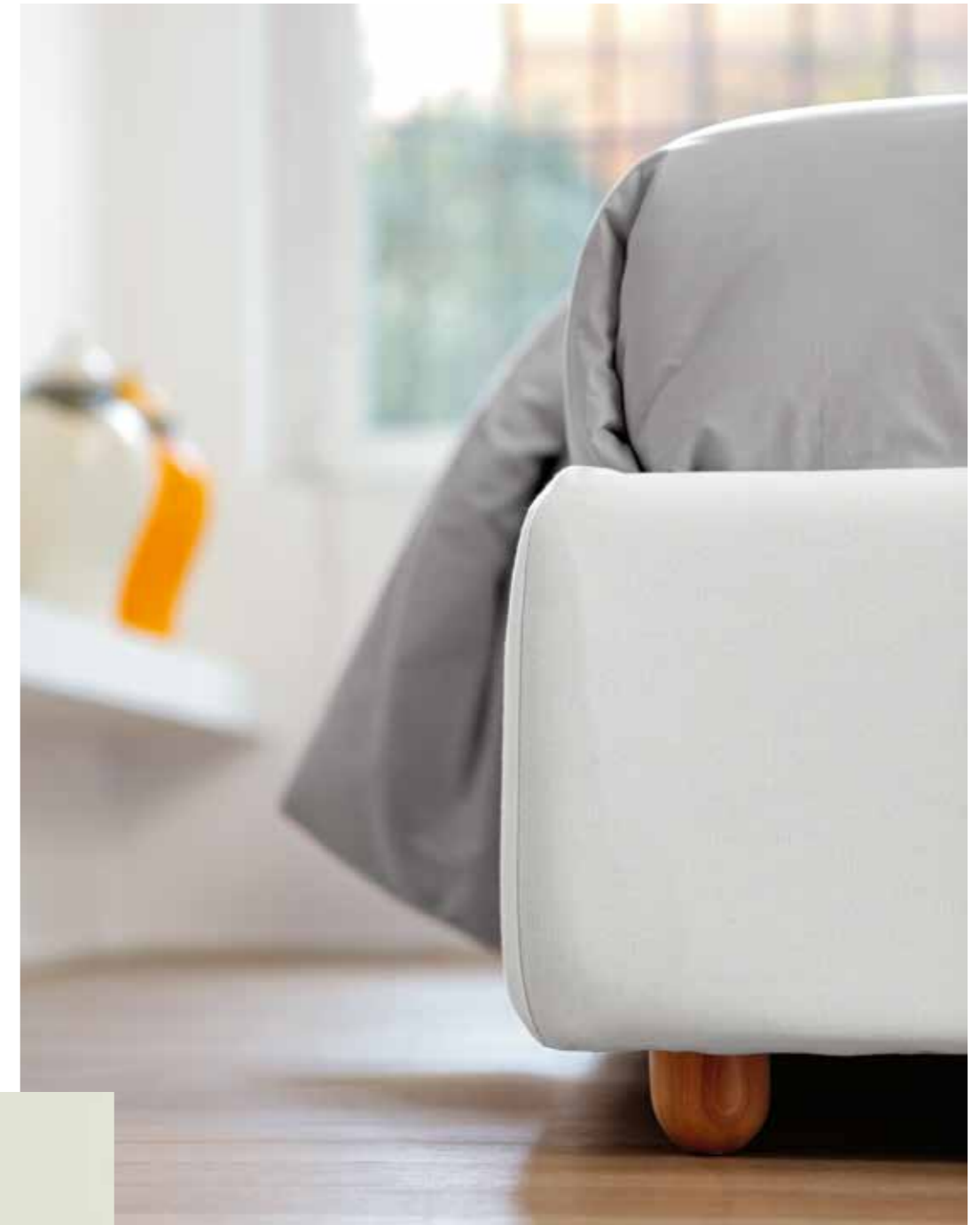

←
Sommier 90
 Silvia 30, cat. C
 piede P2 natural
 P2 natural foot
 H60

↑
Sommier 160
 Panama 320, cat. C
 piede P2 natural
 P2 natural foot
 H60



Sommier e Soggiorno H10

Una base sommier da abbinare direttamente all'arredo della tua stanza. Disponibile con contenitore o con giroletto H10. Piedi a scelta in diverse altezze. Disponibile in tutti i tessuti del nostro campionario.

A Sommier bed base to match to your room furnishing. Available with storage or H10 bed frame base. Choice of different height feet. Available in all fabrics of our samples collection.

↓
Sommier
 Smile goo, cat. C
 piede P2 natural
 P2 natural foot
 H60



↓
Sommier H10 160
 Panama 786, cat. C
 piede P2 natural
 P2 natural foot
 H250



Sommier

↳ Disponibile in tutti i tessuti del nostro campionario ↳ Nelle Larghezze King, 180, 160, Queen, 150, 140, 120, Twin, 90

↳ Available in all the fabrics of our catalogue ↳ Bed sizes available: King, 180, 160, Queen, 150, 140, 120, Twin, 90

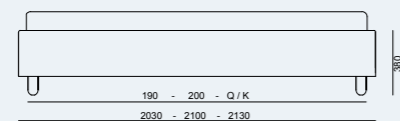
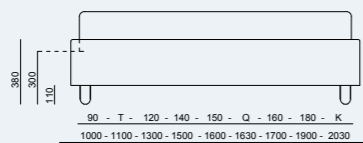
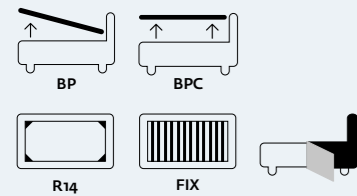

Sommier H10

↳ Disponibile in tutti i tessuti del nostro campionario ↳ Nelle Larghezze King, 180, 160, Queen, 150, 140, 120, Twin, 90

↳ Available in all the fabrics of our catalogue ↳ Bed sizes available: King, 180, 160, Queen, 150, 140, 120, Twin, 90

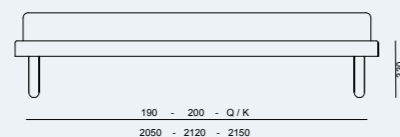
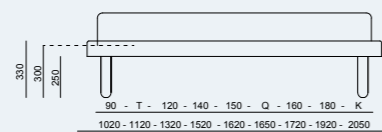
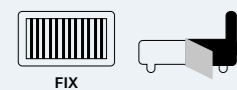

I disegni tecnici fanno riferimento al letto fornito con piedi standard. Al variare dei piedi variano anche l'altezza complessiva del letto e il piano d'appoggio del materasso. The production drawings are referred to the bed with standard feet. Any foot change will also imply a change of the height and of the mattress base.



Zico

design Noctis

—
La classe che ti avvolge
con morbide linee.

—
The class that wraps you
with soft lines.

Zico 160
Mover opticwhite, cat. C
piede pz nero
pz black foot
H60



volumi avvolgenti

disponibile in tutti
i tessuti e pelle



volumes embracing

Available in all
materials and leather.

Zico 160
Mover pearl, cat. C
piede p2 bianco
p2 white foot
H60

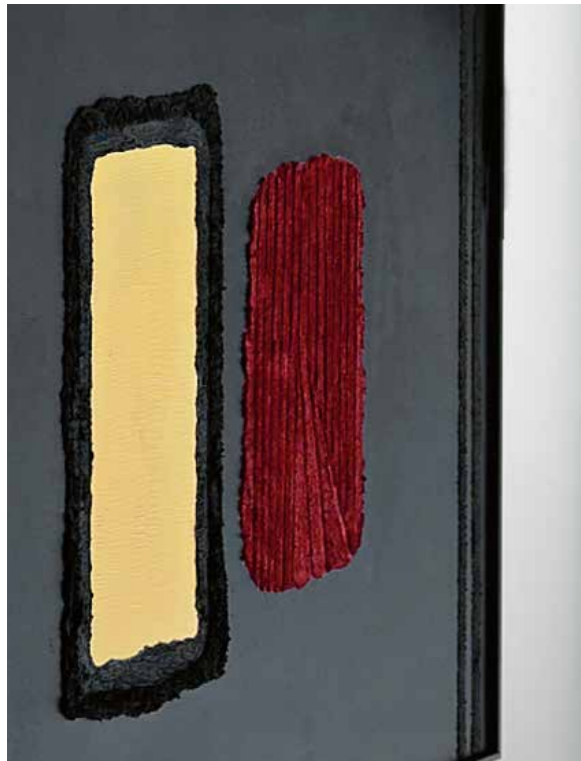

Zico

Caratterizzato da volumi avvolgenti da linee morbide e fluide anche nel profilo del contenitore.

Characterized by embracing volumes and soft and fluide lines even for the storage base profile.



Zico 160
Mover opticwhite, cat. C
piede campana grigio
grey bell foot
H60

**Profilo fluido,
morbide
linee**



**Profile fluid,
linessharing
soft**

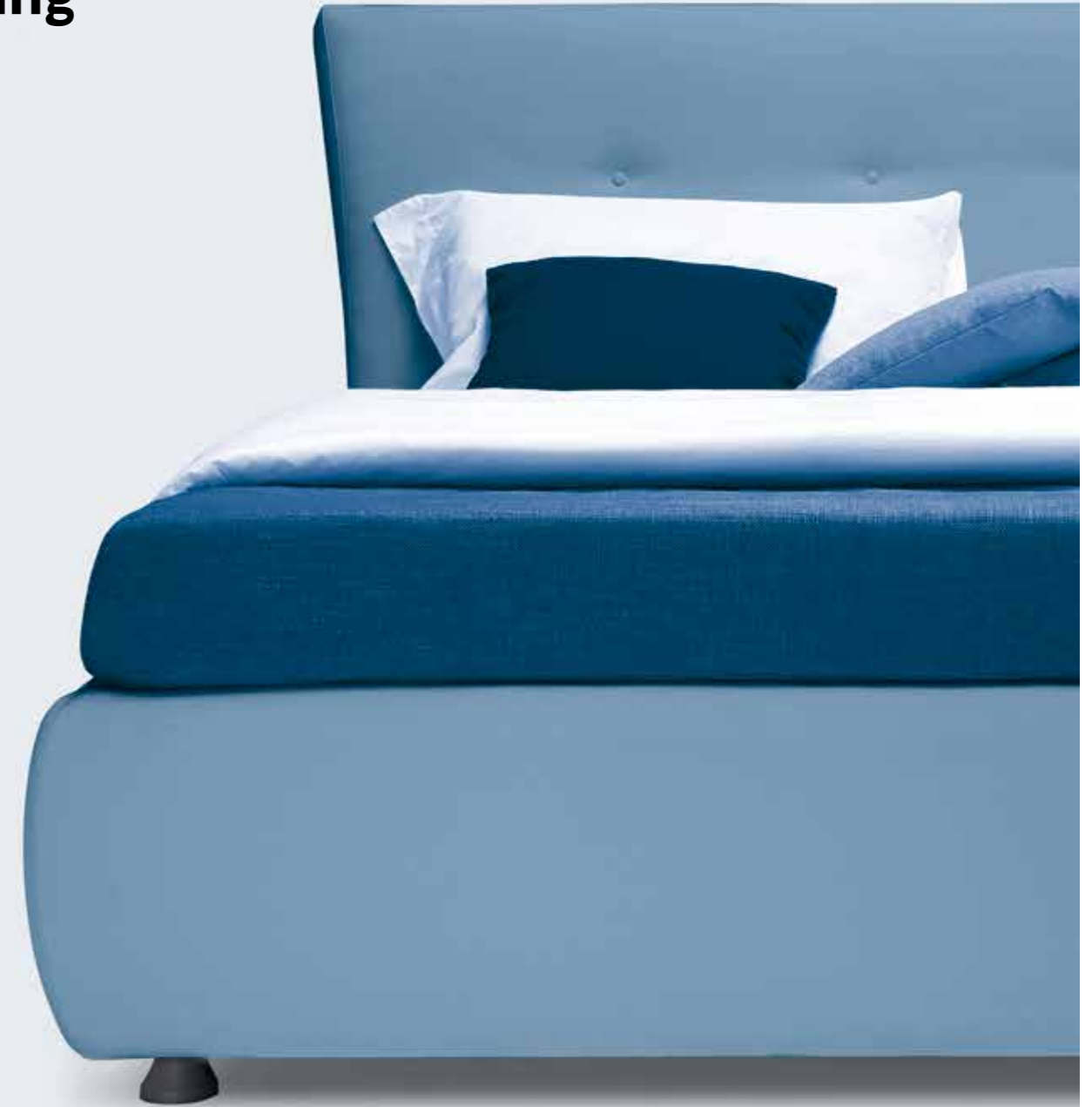

Zico 160
Mover fiordaliso, cat. C
piede campana grigio
grey bell foot
H60

Zico

↳ Disponibile in tutti i tessuti del nostro campionario ↳ Nelle Larghezze King, 180, 160, Queen, 150, 140, 120, Twin, 90

↳ Available in all the fabrics of our catalogue ↳ Bed sizes available: King, 180, 160, Queen, 150, 140, 120, Twin, 90

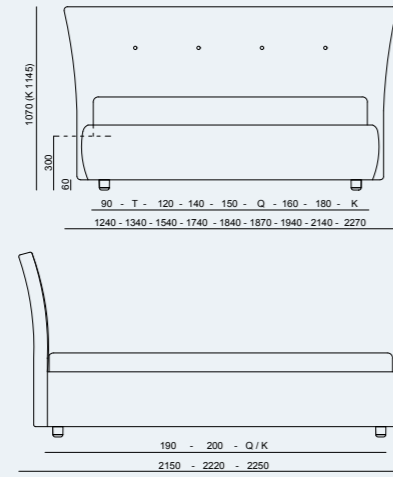
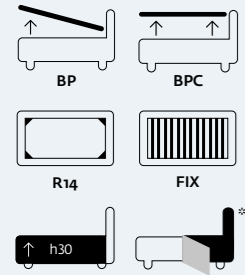

° Sfoderabile previo smontaggio della testiera
Removable after disassembling the headboard

I disegni tecnici fanno riferimento al letto fornito con piedi standard.
Al variare dei piedi variano anche l'altezza complessiva del letto e il piano d'appoggio del materasso. The production drawings are referred to the bed with standard feet. Any foot change will also imply a change of the height and of the mattress base.



Accessori accessories

Noctis ha cura dei vostri sogni in tutti i dettagli. La gamma dei nostri prodotti comprende un'ampia collezione di accessori tessili e biancheria dedicata: cuscini, lenzuola, federe e coprimaterassi in tutte le misure dei letti di nostra produzione.

Noctis takes care of every detail of your dreams. Our catalogue also includes many textile accessories and bed linens: pillows and pillowcases, bed linens and mattress covers are available in all the sizes of our beds.



Noctis 2023

creative director

Mattia e Caterina Priori

graphic design

Maria Grazia Palazzo

photography

AmatiBacciardi

digital work

Annamaria Ferretti

Ringraziamo le persone dello staff

Noctis che oltre a realizzare

i nostri prodotti sono state

anche nostri modelli nella

realizzazione del catalogo.

We would like to thank all the

Noctis staff members who every

day work for the production

of our beds and also kindly

appeared in this catalogue.

Noctis SpA con unico socio

Fraz. Monterolo, 144/c

zona ind. le Ganga

61045 Pergola PU, Italy

t. +39 0721.775505

f. +39 0721.735599

p.iva / cf 01304200411

www.noctis.it

